

KENWOOD

7-Inch WIDE SCREEN MONITOR-RECEIVER

KVT-M700

INSTRUCTION MANUAL

KENWOOD CORPORATION



**Take the time to read through this instruction manual.
Familiarity with installation and operation procedures will help you
obtain the best performance from your new monitor-receiver.**

For your records

Record the serial number, found on the back of the unit, in the spaces designated on the warranty card, and in the space provided below. Refer to the model and serial numbers whenever you call upon your KENWOOD dealer for information or service on the product.

Model KVT-M700 Serial number _____

Contents

Before Use4

- Safety Precautions
- About RDS

Monitor Control Function.....5

- Opening the Monitor
- Closing the Monitor
- Power Off
- Switching the Monitor's Picture
- Switching the Screen Mode
- Switching the AV Output
- Switching to the Angle/Screen Control Screen
- Turning the Monitor Picture Off

Angle Control Screen

- Angle Control Screen
- Adjusting the Angle Position [ANGLE]
- Adjusting the Slide Position [SLIDE]
- Automatic Open/Close [AUTO OPEN-CLOSE]
- Switching to the Screen Control Screen
- Exit the Angle Control Screen

Screen Control Screen

- Adjusting the Picture Quality
- Auto Dimmer [DIM]
- Switching to the Angle Control Screen
- Exit the Screen Control Screen

Menu Function8

Menu Screen

- Selecting the Menu Screen
- Selecting the Setup Menu Screen
- Selecting the Sound Control Menu Screen
- Selecting the External Display Control Screen
- Selecting the Sensor Box Control Screen
- Exit the Menu Screen

Setup Function9

Setup Menu Screen

- Selecting the Touch Panel Adjustment Screen
- Selecting the AV Setup Screen
- Selecting the Clock Adjustment Screen
- Selecting the System Setup Screen
- Selecting the Code Security Screen

Clock Adjustment Screen

- Synchronize Clock [SYNC]
- Manual Clock Adjustment [CLOCK]
- Exit the Clock Adjustment Screen

Code Security Screen

- Security Code
- Exit the Code Security Screen

Touch Panel Adjustment Screen

- Adjusting the Touch Position

AV Setup Screen

- Setting the AV IN-1 Mode [AV-IN1]
- Setting the AV IN-2 Mode [AV-IN2]
- Setting the RGB Mode [RGB]
- Setting the the AV Output Mode [AV-OUT]
- Exit the AV Setup Screen

System Setup Function12

System Setup Screen

- Touch Sensor Tone [BEEP]
- On Screen Display [ON SCREEN]
- Disabled System Indicator [DSI]
- Switching the Setup Screen -1 and 2
- Selectable Illumination [KEY ILLUMI]
- Key Indicator Color [KEY INDICATOR]

- Navigation Announcement [NAV INTERRUPTION]
- Sound Attenuate [NAV GUIDE]
- Exit the System Setup Screen

Sound Control Function14

Sound Control Menu Screen

- Selecting the Audio Setting Screen
- Selecting the System Es Setting Screen
- Selecting the Speaker Select Screen
- Selecting the Tone Control Screen

Audio Setting Screen

- Balance and Fader [BAL/FAD]
- Loudness [LOUD]
- B.M.S. (Bass Management System) [AMP BASS]
- B.M.S. Frequency Offset [AMP FREQ]
- Volume Offset
- Switching the Audio Setting Screen -1 and 2
- System Q [SYSTEM Q]
- System Q Ex [SYSTEM QEx]
- Dual Zone System [2 ZONE]
- Exit the Audio Setting Screen

Speaker Select Screen

- Speaker & Woofer Setting
- Exit the Speaker Select Screen

Tone Control Screen

- Tone Control (System QEx set to OFF)
- Tone Control (System Q Es set to ON)
- Switching to the Tone Control Screen -1 and 2
- Exit the Tone Control Screen

System Es Setting Screen

- System Es
- Exit the System Es Setting Screen

Source Control Function (Common operation)18

- Displaying the On Screen Control
- Changing the Audio Source Mode
- Volume
- Attenuator
- Loudness
- Non-fading Output
- Switching to the Menu Screen
- Changing the Function Buttons
- Changing the Background Mode for the Control Screen
- TEL Mute

FM/AM Tuner Control Function20

- Selecting the FM band
- Selecting the AM band
- Tuning
- Station Preset Memory
- Preset Tuning
- Auto Memory Entry
- Seek Mode
- CRSC
- Traffic Information
- Switching Display
- Switching to the FM/AM List Screen
- Switching to the PTY Search Screen
- Switching to the Name Set Screen
- FM/AM List Screen
- PTY Search Screen

AV Control Function23

- Selecting the On Screen Control
- Selecting the Preset Band TV1 and TV2
- Selecting the Video Input
- Seek Mode
- Selecting the Channel
- Station Preset Memory
- Auto Memory Entry
- Recalling a Preset Station
- Switching to the TV List Screen
- Switching to the Name Set Screen
- TV List Screen

CD Player Control Function.....25

- Pause and play
- Fast Forwarding and Reversing
- Track Search
- Track Repeat
- Track Scan
- Random Play
- Switching Display
- Switching to the Name Set Screen

Disc Changer Control Function.....26

- Pause and play
- Fast Forwarding and Reversing
- Track Search
- Album Search
- Track Repeat
- Album Repeat
- Track Scan
- Random Play
- Magazine Random Play
- Switching Display
- Switching to the Disc List Screen
- Switching to the Name Set Screen
- Disc List Screen

Name Set Function28

- Station Name Preset (SNPS)/
- Disc Name Preset (DNPS)

Other Option Control Function.....29

Weather Band Tuner Control

- Selecting the Channels

SIRIUS Tuner Control

- Selecting the Preset Band
- Selecting the Channel
- Station Preset Memory
- Seek Mode
- Channel Scan
- Channel Search
- Switching to the Information Screen

External Display Control

- Switching the Display
- Exit the External Display Control Screen

Sensor Box Control

- Setting the Menu
- Exit the Sensor Box Control Screen

Remote Control Function34

Installation36

Troubleshooting Guide.....43

Specifications46

The illustrations of the display and the panel appearing in this manual are examples used to explain more clearly how the controls are used. Therefore, what appears on the display in the illustrations may differ from what appears on the display on the actual equipment, and some of the illustrations on the display may represent something impossible in actual operation.

Before Use

Safety Precautions

▲WARNING

To prevent injury and/or fire, take the following precautions:

- Ensure that the unit is securely installed. Otherwise it may fly out of place during collisions and other jolts.
- When extending the ignition, battery or ground wires, make sure to use automotive-grade wires or other cables with an area of 0.75mm² (AWG18) or more to prevent wire deterioration and damage to the wire coating.
- To prevent short circuits, never put or leave any metallic objects (e.g., coins or metal tools) inside the unit.
- If the unit starts to emit smoke or strange smells, turn off the power immediately and consult your Kenwood dealer.
- Do not touch the liquid crystal fluid if the LCD is damaged or broken due to shock. The liquid crystal fluid may be dangerous to your health or even fatal.
If the liquid crystal fluid from the LCD contacts your body or clothing, wash it off with soap immediately.

▲CAUTION

To prevent damage to the machine, take the following precautions:

- Make sure to ground the unit to a negative 12V DC power supply.
- Do not open the top or bottom covers of the unit.
- Do not install the unit in a spot exposed to direct sunlight or excessive heat or humidity. Also avoid places with too much dust or the possibility of water splashing.
- Do not subject the faceplate to excessive shock, as it is a piece of precision equipment.
- When replacing a fuse, only use a new one with the prescribed rating. Using a fuse with the wrong rating may cause your unit to malfunction.
- To prevent short circuits when replacing a fuse, first disconnect the wiring harness.
- Do not use any screws except for the ones provided. The use of improper screws might result in damage to the main unit.
- You cannot view video pictures whilst the vehicle is moving. To enjoy TV/video pictures, find a safe place to park and engage the parking brake.

NOTE

- If you experience problems during installation, consult your Kenwood dealer.
- If the unit does not seem to be working right, try pressing the reset button first. If that does not solve the problem, consult your Kenwood dealer.

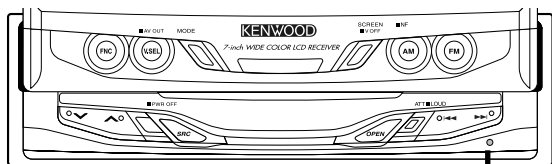

Reset button

- We recommend the use of the Security Code function (see p. 10) to prevent theft.

Cleaning the Unit

If the faceplate of this unit is stained, wipe it with a dry soft cloth such as a silicon cloth.

If the faceplate is stained badly, wipe the stain off with a cloth moistened with neutral cleaner, then wipe neutral detergent off.

▲CAUTION

Applying spray cleaner directly to the unit may affect its mechanical parts. Wiping the faceplate with a hard cloth or using a volatile liquid such as thinner or alcohol may scratch the surface or erase characters.

Screen brightness during low temperatures

When the temperature of the unit falls such as during winter, the liquid crystal panel's screen will become darker than usual. Normal brightness will return after using the monitor for a while.

IMPORTANT INFORMATION

About the disc changer/CD player to be connected:

To connect a disc changer having the "O-N" switch to this unit, set the "O-N" switch to "N".

To connect a disc changer having no "O-N" switch to this unit, the converter cord CA-DS100 and/or switching adapter KCA-S210A are required as options.

A disc changer doesn't work when it is connected without using these options.

If a model with no "O-N" switch is connected, some unavailable functions and information that cannot be displayed are generated.

Note that none of the KDC-C100, KDC-C302, C205, C705, and non-Kenwood CD changers can be connected.

⚠ You can damage both your unit and the CD changer if you connect them incorrectly.

FCC WARNING

This equipment may generate or use radio frequency energy. Changes or modifications to this equipment may cause harmful interference unless the modifications are expressly approved in the instruction manual. The user could lose the authority to operate this equipment if an unauthorized change or modification is made.

About RDS

RDS (Radio Data System)

RDS is a service used by radio stations to transmit data outside normal radio broadcast signals.

When an RDS station is received, you can immediately find out what kind of data is being transmitted by looking at the program service name, which appears in the display after the frequency.

The RDS indicator turns on when an RDS station is being received.

Alarm

When an emergency transmission (announcing disasters, etc.) is made, the current function will be interrupted to allow the warning to be received under the following conditions:

during tuner reception, or when the Traffic Information function is turned on.

Monitor Control Function

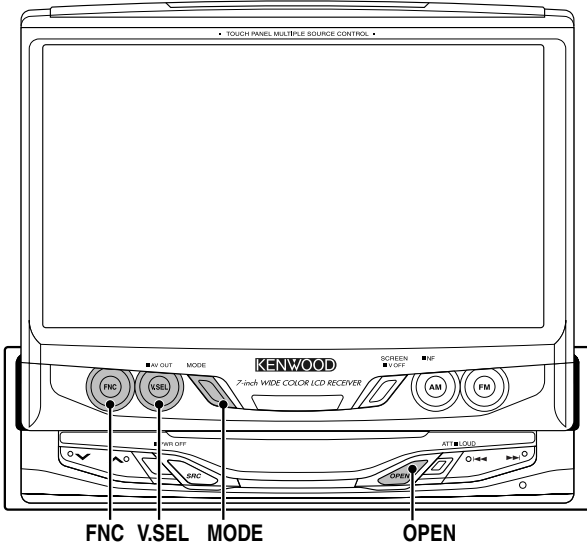
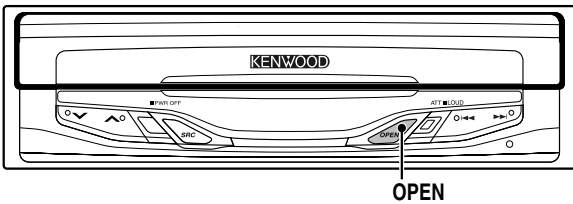

Opening the Monitor

- 1 Set the vehicle's parking brake.
- 2 Press the [OPEN] button.
The monitor will open.

- The gear shift lever or other parts may interfere with the monitor when it opens. If so, move the gear shift lever (being sure to do so safely) before operating the set. (The monitor is drawn back in automatically if it cannot be opened normally due to an obstacle.)
- The monitor cannot be opened unless the parking brake is set.
- The position to which the monitor slides or angle when the power is turned on can be set. (Refer to the angle control screen on (Page 7).

Closing the Monitor

Press the [OPEN] button.
The monitor will close.

- The monitor cannot be closed unless the parking brake is set.

Power Off

Press the [SRC] button for at least 1 second.

Power On

Press the [SRC] button.

Switching the Monitor's Picture

Press the [V.SEL] button.

Each time the button is pressed the monitor's picture switches as follows:

During the KTC-V500N is not connected:

Display	Picture
"VD 1"	Video 1 (AV IN1 setting during "VD")
"VD 2"	Video 2 (AV IN2 setting during "VD")
"NAV"	RGB (from I/F terminal: RGB setting during "ON")

During the KTC-V500N is connected:

Display	Picture
"VD 1"	Video 1 (AV-IN1 setting during "VD")
"VD 2"	Video 2 (AV IN2 setting during "VD")
"NAV"	RGB (from I/F terminal: RGB setting during "ON")
"ch"	Television

- For "AV IN" and "RGB" setting, refer to <AV Setup Screen>. (Page 11).
- The "NAV", "VD 1" and "VD 2" displays can be changed by the <AV Setup Screen>.



You cannot view television and video pictures whilst the vehicle is moving. To enjoy television and video pictures, find a safe place to park and engage the parking brake.

Monitor Control Function

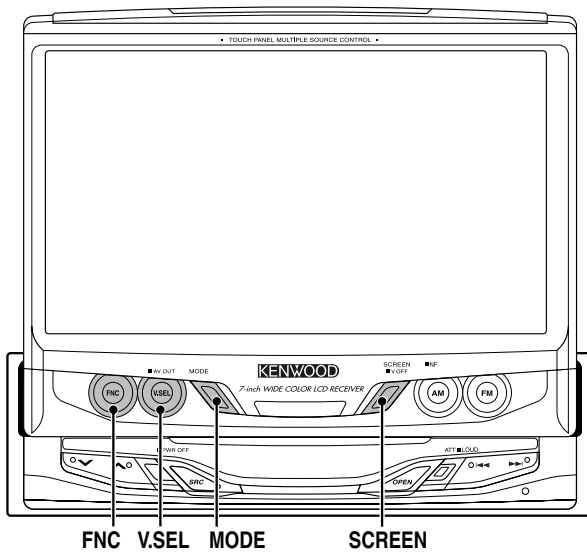

Switching the TV/Video Screen Mode

Press the [MODE] button.

Each time the button is pressed the screen mode switches as follows:

Display	Setting
"FULL"	Full screen mode
"ZOOM"	Zoom screen mode
"JUST"	Just screen mode
"CINEMA"	Cinema screen mode
"NORMAL"	Normal screen mode

You cannot operate when the navigation picture is displayed.

Switching the AV Output

Press the [V.SEL] button for at least 1 second.

Each time the button is pressed for at least 1 second the AV output switches as follows:

Display	Setting
"VIDEO1"	Picture/sound input from the AV IN 1 terminal
"VIDEO2"	Picture/sound input from the AV IN 2 terminal
"TV"	Picture/sound of the television (During the KTC-V500N is connected)

Screen Mode

• NORMAL

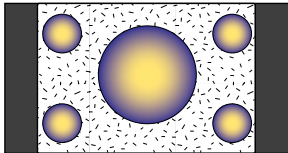

• FULL

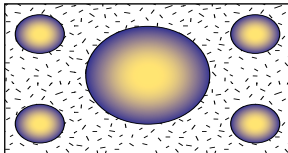

• JUST

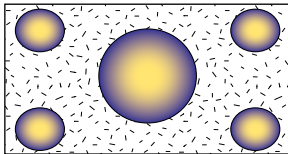

• ZOOM

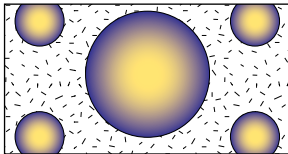

• CINEMA

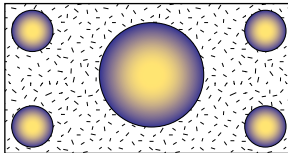

Switching to the Angle/Screen Control Screen

Press the [SCREEN] button.

(Page 7)

Turning the Monitor Picture Off

Press the [SCREEN] button for at least 1 second.

The picture reappears when the one of the SCREEN, MODE, V.SEL or FNC buttons is pressed.

Angle Control Screen

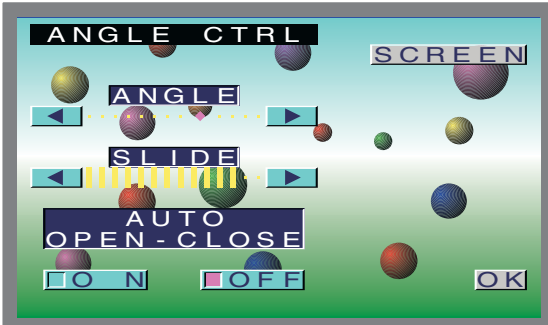

Screen Control Screen

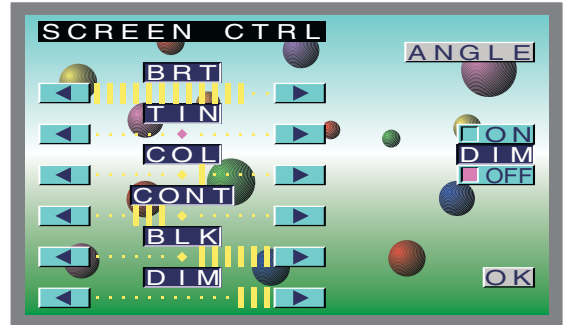

Adjusting the Angle Position [ANGLE]

The monitor slants back one step:

Touch the [▶] button.

The monitor slants forward one step:

Touch the [◀] button.

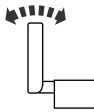

- The angle can be adjusted in 9 steps.
- The next time the monitor is opened it stops at the set location.

Adjusting the Slide Position [SLIDE]

The monitor to the front:

Touch the [▶] button.

The monitor to the back:

Touch the [◀] button.



- The next time the monitor is opened it stops at the set location.

Automatic Open/Close [AUTO OPEN-CLOSE]

Touch	Setting
[■ON]	Switch the ACC on/off to open/close the monitor
[■OFF]	Use the OPEN button to open/close the monitor

- If the shift lever or other parts of the vehicle interfere with the monitor when it opens, select "OFF".

Switching to the Screen Control Screen

Touch the [SCREEN] button.

Exit the Angle Control Screen

Touch the [OK] button.

Adjusting the Picture Quality

Item	Touch	Setting
BRT	[▶]	Brighter screen
	[◀]	Darker screen
TIN	[▶]	Stronger green level
	[◀]	Stronger red level
COL	[▶]	Deeper color
	[◀]	Paler color
CONT	[▶]	Stronger contrast
	[◀]	Less contrast
BLK	[▶]	Less black level
	[◀]	Stronger black level
DIM	[▶]	Brighter screen
	[◀]	Darker screen

- The [TIN] and [COL] cannot be adjusted for the navigation picture or the control screen.
- Separate picture quality settings can be stored for the television, video, control screens and navigation screens.

Auto Dimmer Function On/Off [DIM]

Touch	Setting
[■ON]	The [DIM] level can be adjusted. Also, when the area around the monitor dark it's at the brightness level set by the [DIM].
[■OFF]	The [DIM] items can't be adjusted. Also, even if the area around the monitor is dark, it can't be changed from the brightness set by [BRT].

Switching to the Angle Control Screen

Touch the [ANGLE] button.

Exit the Screen Control Screen

Touch the [OK] button.

Menu Function

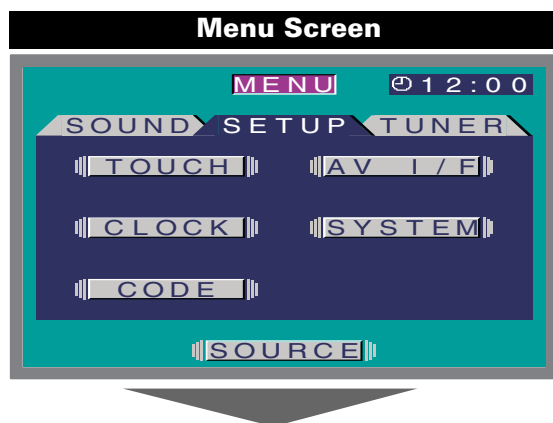
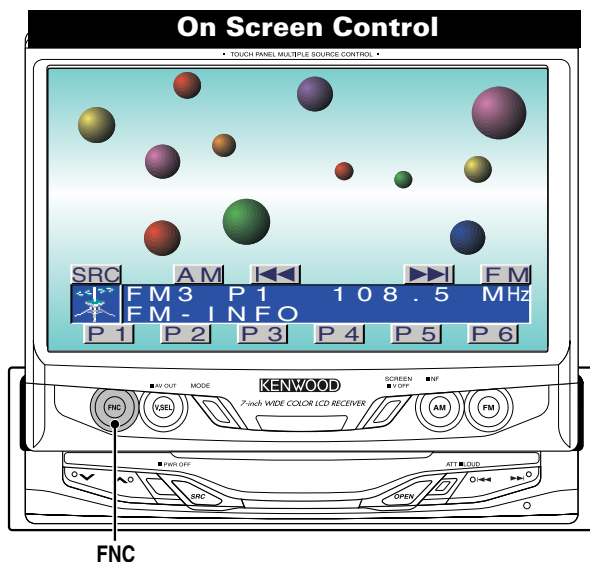

Selecting the Menu Screen

- 1 Displaying the On Screen Control**
Press the [FNC] button to display the on screen control.
 If you make no button operation for 10 seconds, the on screen control is automatically cancelled.
- 2 Selecting the Control Screen**
When the [FNC] button is pressed during on screen control display, it switches to control screen.
- 3 Selecting the Menu Screen**
Touch the [MENU] button to switch the menu screen.

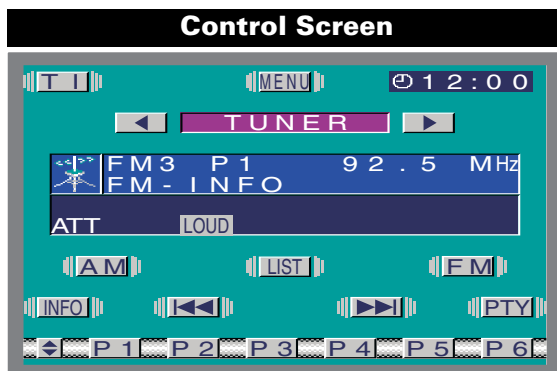

Selecting the Setup Menu Screen

Touch the [SETUP] button.
(☛ Page 9)

Selecting the Sound Control Menu Screen

Touch the [SOUND] button.
(☛ Page 14)

Selecting the External Display Control Screen

Touch the [EXT] button.
(☛ Page 32) <During the KPA-SD100 is connected>

Selecting the Sensor Box Control Screen

Touch the [SENS] button.
(☛ Page 32) <During the KPA-SS100 is connected>

Exit the Menu Screen

Touch the [SOURCE] button.
Return to source control screen.

Setup Function

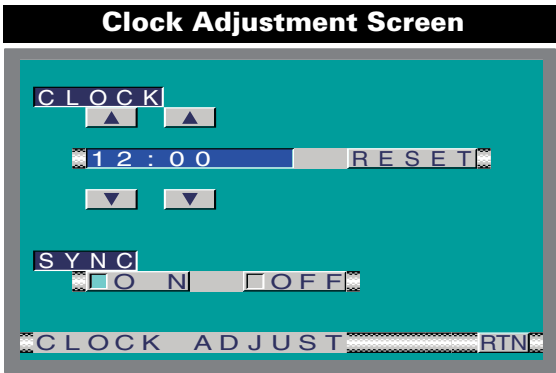
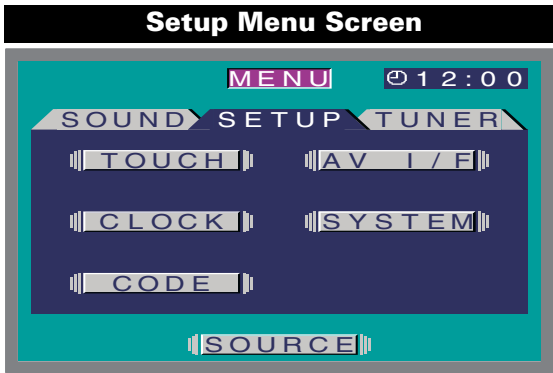

Selecting the Touch Panel Adjustment Screen

The touch panel can be adjusted if the position touched and the operation performed do not match. Touch the [TOUCH] button. (Page 10)

Selecting the AV Setup Screen

Touch the [AV I/F] button. (Page 11)

Selecting the Clock Adjustment Screen

Touch the [CLOCK] button. (Page 9)

Selecting the System Setup Screen

Touch the [SYSTEM] button. (Page 12)

Selecting the Code Security Screen

Press the [CODE] button for at least 2 seconds. (Page 10)

Synchronize Clock [SYNC]

Synchronizing the RDS station time data and this unit's clock.

Touch	Setting
[ON]	Synchronizes the time.
[OFF]	Adjust the time manually.

It takes 3 to 4 minutes to synchronize the clock.

Manual Clock Adjustment [CLOCK]

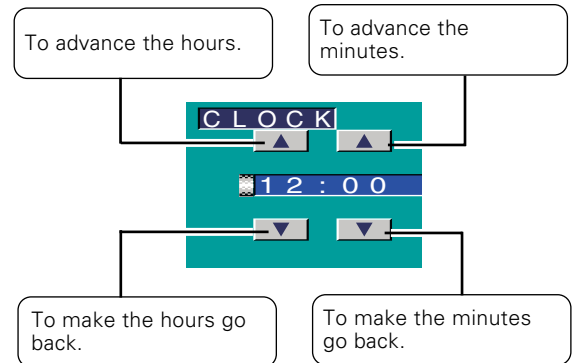

Setting the Minutes to "00":

Touch the [RESET] button.

- Touch the [RESET] button while the minute is below "30" rounds it off, and while the minute is "30" or more rounds it up.
- This adjustment can be done when the <SYNC> is set as OFF.

Exit the Clock Adjustment Screen

Touch the [RTN] button. Return to the setup menu screen.

Setup Function

Code Security Screen



Touch Panel Adjustment Screen

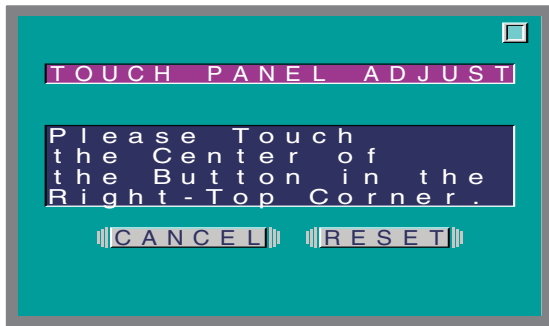

Security Code

Because authorization by the Security Code is required when it's removed from the vehicle, personalizing this unit is by using the Security Code is a help in preventing theft.

 When the Security Code function is activated, the code can't be changed and the function can't be released. Note, the Security Code can be set as the 4 digit number of your choice.

1 Enter the Security Code

Touch the [0] — [9] button.

 If you enter the wrong number, touch [CLR]. The last entered number is cleared.

2 Confirm the Security Code

Touch the [OK] button.

3 Do the step 1 and 2 step operation, and reenter the security code.

Return to the setup menu screen.

 When the wrong Code is entered in steps 1, repeat from step 1.

Press the Reset button and when it's removed from the battery power source

1 Turn the power ON.

2 Do the step 1 and 2 operation, and enter the Security Code.

The "ALL OFF" screen is displayed.
The unit can be used.

Exit the Code Security Screen

Touch the [RTN] button.
Return to the setup menu screen.

Adjusting the Touch Position

The touch panel can be adjusted if the position touched and the operation performed do not match.

1 Accurately touch the mark at the upper right.

2 Accurately touch the mark at the lower left.

When the mark at the lower left is touched, the adjustment is completed and the system setup menu screen reappears.

- 
- If the [CANCEL] button is touched without touching the button at the upper right, the adjustment is canceled and the screen that was set before switching to the system setup menu reappears.
 - If the [CANCEL] button is touched after touching the button at the upper right, the button at the upper right reappears.
 - If the [RESET] button is touched, the settings are reset to the factory defaults and the setup menu screen reappears.

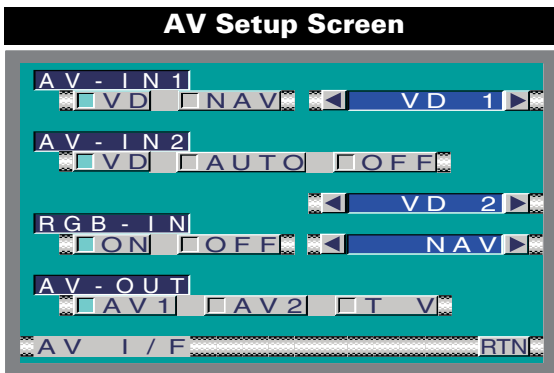

Setting the AV IN-1 Mode [AV-IN1]

Touch	Setting
[■NAV]	It becomes the navigation mode setting. Operate the V.SEL button when the image from the navigation unit connected to AV IN1 terminal is shown on the monitor.
[■VD]	It becomes the video mode setting. Operate the V.SEL button when the image from the device connected to AV IN1 terminal is shown on the monitor.

Select the AV-IN1 input display:
 Selecting the display when this device is switched to internal AV-IN1 terminal input source.
 Each time you touch the [◀] or [▶] button, the display switches as follows:
 "VD 1" ↔ "VIDEO1" ↔ "NAV1" ↔ "DVD1" ↔ "VCR1" ↔ "VCD1" ↔ "GAME1" ↔ "AUX1"

Setting the AV IN-2 Mode [AV-IN2]

Touch	Setting
[■VD]	It becomes the video mode setting. Operate the V.SEL button when the image from the device connected to AV IN2 terminal is shown on the monitor.
[■AUTO]	It becomes the auto video mode setting. When the video signal input to the AV IN2 terminal, the monitor image is switched to the image of the device connected to the AV IN2 terminal.
[■OFF]	It becomes the OFF mode setting. Use this setting when there's nothing connected to the AV IN2 terminal.

Select the AV-IN2 input display:
 Selecting the display when this device is switched to internal AV-IN2 terminal input source.
 Each time you touch the [◀] or [▶] button, the display switches as follows:
 "VD 2" ↔ "VIDEO2" ↔ "NAV2" ↔ "DVD2" ↔ "VCR2" ↔ "VCD2" ↔ "GAME2" ↔ "AUX2" ↔ "CAMERA"

Setting the RGB Mode [RGB]

Touch	Setting
[■ON]	It becomes the RGB mode setting. Operate the V.SEL button when the image from the navigation unit connected to I/F terminal is shown on the monitor.
[■OFF]	It becomes the OFF mode setting. Use this setting when there's nothing connected to the I/F terminal.

Select the I/F input display:
 Selecting the display when this device is switched to internal I/F terminal input source.
 Each time you touch the [◀] or [▶] button, the display switches as follows:
 "NAV" ↔ "DVD" ↔ "DVB" ↔ "RGB"

Setting the AV Output Mode

Touch	Setting
[■AV1]	Picture/sound from AV IN1 terminal.
[■AV2]	Picture/sound from AV IN2 terminal.
[■TV]	Picture/sound from television. (During the KTC-V500N is connected)

Exit the AV Setup Screen

Touch the [RTN] button.
 Return to the setup menu screen.

System Setup Screen-1

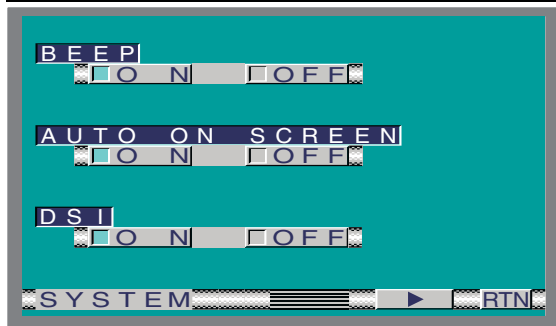

Touch Sensor Tone [BEEP]

Setting the operation check sound (beep sound) ON/OFF.

Touch	Setting
[■ON]	Touch sensor tone is turned on
[■OFF]	Touch sensor tone is turned off

On Screen Display [AUTO ON SCREEN]

Touch	Setting
[■AUTO]	When a button on the main unit or remote control unit is pressed, or the disc track is changed, the audio source control information is temporarily superimposed on the picture.
[■MANU]	When the lower center of the screen is touched while a TV/video picture is displayed, the audio source control information is temporarily superimposed on the picture.

Disabled System Indicator [DSI]

A red indicator (Reset button) will blink on the unit after the ignition Key switch is off, warning potential thieves.

Touch	Setting
[■ON]	LED flashes.
[■OFF]	LED OFF.

Switching the Setup Screen -1 and 2

Touch the [◀] or [▶] button.

System Setup Screen-2



Selectable Illumination [KEY ILLUMI]

Selecting the button illumination color as green or red.

Touch	Setting
[■GREEN]	The illumination color is green.
[■RED]	The illumination color is red.

Key Indicator Color [KEY INDICATOR]

Selecting the OPEN and SRC button indicator color. Touch the [◀] or [▶] button.

Display	Setting
"SOURCE"	The color changes according to the selected source.
"MARS"	Red
"LIME"	Green
"SUNSET"	Red Green
"SKY"	Blue
"VIOLET"	Violet
"AQUA"	Blue Green
"MOON"	White

Navigation Announcement [NAV INTERRUPTION]

The navigation voice is output from the front speaker at navigation voice guide announcement time.

Touch	Setting
[■ON]	Announcement function is on
[■OFF]	Announcement function is off

 This function available when the KENWOOD navigation unit is connected to the I/F terminal.

Sound Attenuate [NAV GUIDE]

The rear speaker sound is attenuate during the navigation voice output time.

Touch	Setting
[■ATT]	Rear speaker attenuate function is on
[■SOUND]	Rear speaker attenuate function is off

 This function available when the KENWOOD navigation unit is connected to the I/F terminal.

Exit the System Setup Screen

Touch the [RTN] button.
Return to the setup menu screen.

Sound Control Function

Sound Control Menu Screen



Selecting the Audio Setting Screen

Touch the [AUDIO] button. (☛ Page 14)

You cannot operate when the standby mode is selected.

Selecting the System Es Setting Screen

Touch the [SYS Es] button. (☛ Page 17)

You cannot operate when the standby mode is selected.

Selecting the Speaker Select Screen

Touch the [SP SEL] button. (☛ Page 16)

You can operate when the standby mode is selected.

Selecting the Tone Control Screen

Touch the [TONE] button. (☛ Page 16)

You cannot operate when the standby mode is selected.

Audio Setting Screen-1

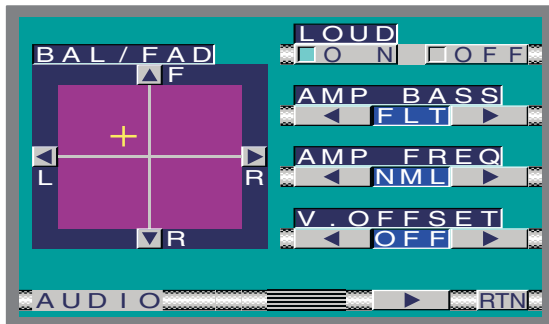

Balance and Fader [BAL/FAD]

Touch	Setting
[◀]L	The sound in the left channel is emphasized.
[▶]R	The sound in the right channel is emphasized.
[▲]F	The sound in the front channel emphasized.
[▼]R	The sound in the rear channel emphasized.

Loudness [LOUD]

Compensating for low and high tones during low volume.

Touch	Setting
[■]ON	Loudness function is turned on
[■]OFF	Loudness function is turned off

When the Loudness function is ON, the "LOUD" indicator is ON in the source control screen.

B.M.S. (Bass Management System) [AMP BASS]

Adjust the bass boost level of the external amplifier using the main unit.

Touch the [◀] or [▶] button.

Display	Setting
"FLT"	Bass boost level is flat.
"+6dB"	Bass boost level is low (+6dB).
"+12dB"	Bass boost level is mid (+12dB).
"+18dB"	Bass boost level is high (+18dB).

• Refer to the catalog or instruction manual for power amplifiers that can be controlled from this unit.
• For amplifiers there are the model that can be set from Flat to +18 dB, an the model that can be set from Flat to +12 dB. When and amplifier is connected that can only be set to +12dB, even if "+18dB" is selected it won't operate correctly.

B.M.S. Frequency Offset [AMP FREQ]

Setting the central frequency boosted by B.M.S.

Touch the [◀] or [▶] button.

Display	Setting
"NML"	Boost with the normal central frequency.
"LOW"	Drop the normal central frequency 20%.

Refer to the catalog or instruction manual for power amplifiers that can be controlled from this unit.

Audio Setting Screen-2

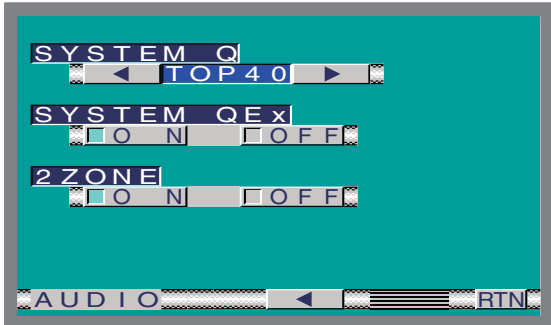

Dual Zone System [2 ZONE]

The following operation allows separate sound sources to control the output of the front and rear speakers.

Touch	Setting
[ON]	The dual zone system function is on. AV-OUT sound send to the rear speaker.
[OFF]	The dual zone system function is off.

- When the Dual Zone System is ON, there is no rear channel audio control or other effect.
- When you set the Dual zone system to ON while the non-fading preout is switched ON, the sound of the non-fading preout isn't output.

Exit the Audio Setting Screen

Touch the [RTN] button.
Return to the sound control menu screen.



Sound Control Function

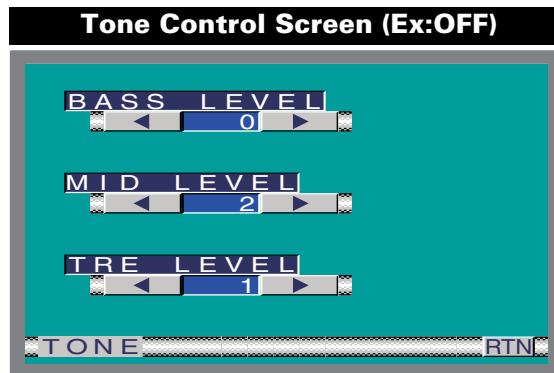
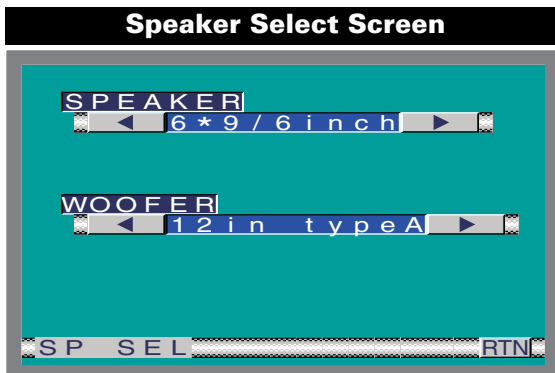

Speaker & Woofer Setting

Fine-tuning so that the System Q value is optimal when setting the speaker and woofer type.

Touch the [◀] or [▶] button.

In Speaker setting mode [SPEAKER]

Display	Speaker type
"OFF"	Off
"6*9/6inch"	For 6 & 6x9 inch speaker
"5/4inch"	For 5 & 4 inch speaker
"OEM"	For the OEM speaker

In Woofer setting mode [WOOFER]

Display	Woofer type
"OFF"	Off
"12in typeA"	12 inch A type
"10in typeA"	10 inch A type
"12in typeB"	12 inch B type
"10in typeB"	10 inch B type
"12in typeC"	12 inch C type
"10in typeC"	10 inch C type
"8inch"	8 inch type
"12in typeD"	12 inch D type
"10in TypeD"	10 inch D type

Exit the Speaker Select Screen

Touch the [RTN] button.
Return to the sound control menu screen.

Tone Control (System QEx set to OFF)

Touch the [◀] or [▶] button.

Display	Adjustment Item	Range
"BASS LEVEL"	Bass level	-8 — +8
"MID LEVEL"	Middle level	-8 — +8
"TRE LEVEL"	Treble level	-8 — +8

Exit the Tone Control Screen

Touch the [RTN] button.
Return to the sound control menu screen.

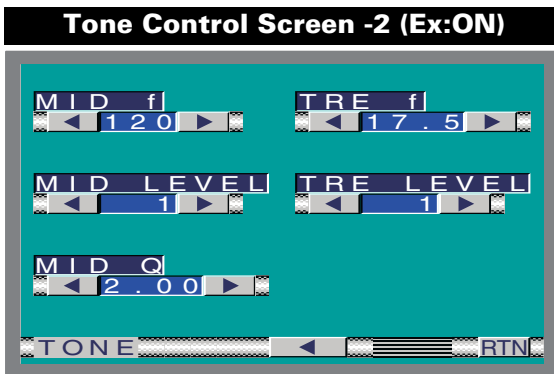
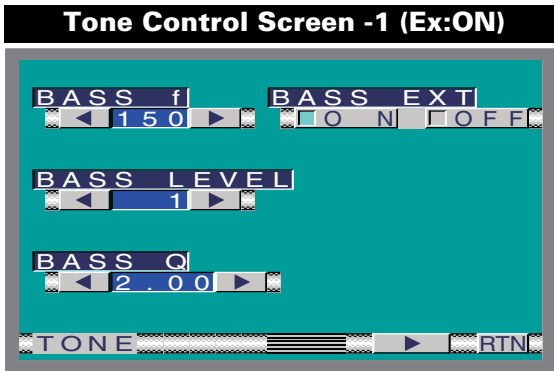

Tone Control (System QEx set to ON)

Touch the [◀] or [▶] button.

Display	Adjustment Item	Range
"BASS f"	Bass Center Frequency	60/70/80/100 or 150 Hz
"BASS LEVEL"	Bass level	-8 — +8
"BASS Q"	Bass Q Factor	1.00/ 1.25/ 1.50/ 2.00
"BASS EXT"	Bass Extend	■ON ■OFF
"MID f"	Middle Center Frequency	0.5/1.0/1.5/ 2.0kHz
"MID LEVEL"	Middle level	-8 — +8
"MID Q"	Middle Q Factor	1.00/2.00
"TRE f"	Treble Center Frequency	10.0/12.5/15.0/ 17.5 kHz
"TRE LEVEL"	Treble level	-8 — +8

- According to the Bass Q Factor setting value, the frequencies that can be set in Bass Center Frequency change as shown below.

Bass Q Factor	Bass Center Frequency
1.00/1.25/1.50	60/70/80/100 Hz
2.00	60/70/80/150 Hz

- When the Bass Extend is set to ON, low frequency response is extended by 20%.

Switching the Tone Control Screen -1 and 2

Touch the [◀] or [▶] button.

Exit the Tone Control Screen

Touch the [RTN] button.
Return to the sound control menu screen.

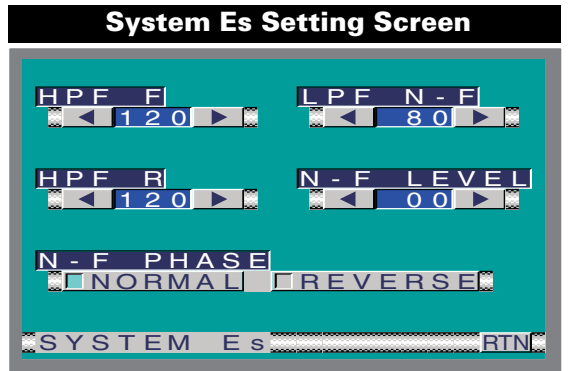

System Es

Touch the [◀] or [▶] button.

Display	Adjustment Item	Range
"HPF F"	Front High Pass Filter	Through/40/60/ 80/100/120/150/ 180/220 (Hz)
"HPF R"	Rear High Pass Filter	Through/40/60/ 80/100/120/150/ 180/220 (Hz)
"LPF N-F"	Non-Fading Low Pass Filter	50/80/120/ Through (Hz)
"N-F LEVEL"	Non-Fading level	-15 — +15
"N-F PHASE"	Non-Fading Phase	■NORMAL (0°) ■REVERSE(180°)

Exit the System Es Screen

Touch the [RTN] button.
Return to the sound control menu screen.

Source Control Function (Common operation)

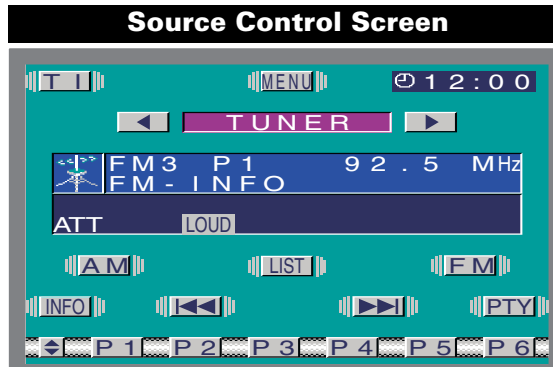
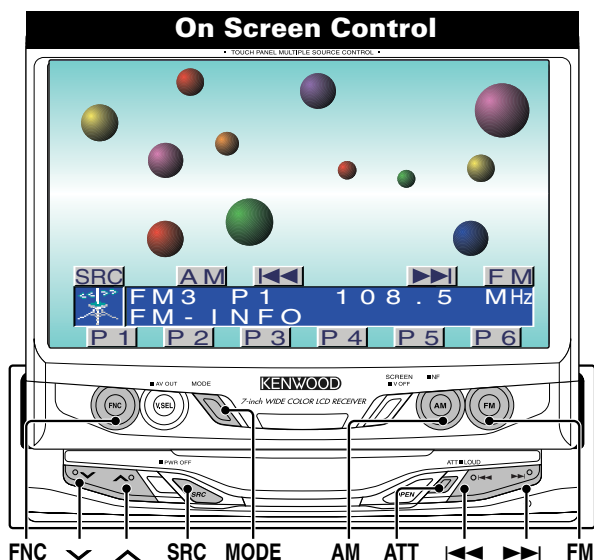

Displaying the On Screen Control

Selecting the On Screen Control

Press the [FNC] button to switch the on screen control display.

If you make no button operation for 10 seconds, the on screen control is automatically cancelled.

Selecting the Control Screen

When the FNC button is pressed during on screen control display, it switches to control screen.

Changing the Audio Source Mode

<In Monitor's button/ On Screen Control>

Press/ Touch the [SRC] button.

<In Source Control Screen>

Touch the [◀] or [▶] button.

Source required	Display
FM/AM Tuner	"TUNER"
External CD player	"CD"
External disc changer	"DISC-CH" "MD-CH"
Video & External TV Tuner	"AV"
Auxiliary input	"AUX"
External SIRIUS Tuner	"SIRIUS"
External Weather Band Tuner	"WBT"
Standby (Illumination only mode)	"ALL OFF"

For Auxiliary input one of the below optional accessories is necessary.

- KCA-S210A
- CA-C1AX
- CD changer with an Auxiliary input function installed.

Volume

Increasing Volume:

Press the [^] button.

Decreasing Volume:

Press the [v] button.

Attenuator

Turning the volume down quickly.

Press the [ATT] button.

Each time the button is pressed the Attenuator turns ON or OFF.

When it's ON, the "ATT" indicator is ON.

Loudness

Compensating for low and high tones during low volume.

Press the [ATT] button for at least 1 second.

Each time the button is pressed for at least 1 second the Loudness turns ON or OFF.

When it's ON, "LOUD" indicator is ON.

Non-fading Output

Turning the Non-fading output ON or OFF.

Press the [AM] button for at least 1 second.

Each time the button is pressed for at least 1 second the Non-fading output switches ON or OFF.

Switching to the Menu Screen

Touch the [MENU] button. (▶ Page 8)

Changing the Function Buttons

Touch the [◆] button.

Each time the button is touched the under function buttons change.

Changing the Background Mode for the Control Screen

You can select the background between 11 different patterns for the source control screen and menu screen.

Press the [MODE] button.

Each time the button to change the background mode.

TEL Mute

The audio system automatically mutes when a call comes in.

When a call comes in

"CALL" is displayed.
The audio system pauses.

Listening to the audio during a call

Press the [SRC] button.
The "CALL" display disappears and the audio system comes back ON.

When the call ends

Hang up the phone.
The "CALL" display disappears and the audio system comes back ON.

FM/AM Tuner Control Function

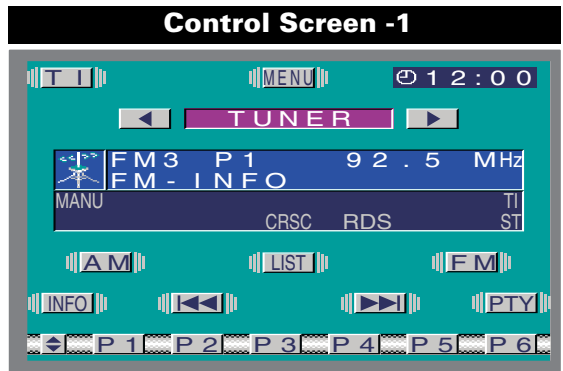
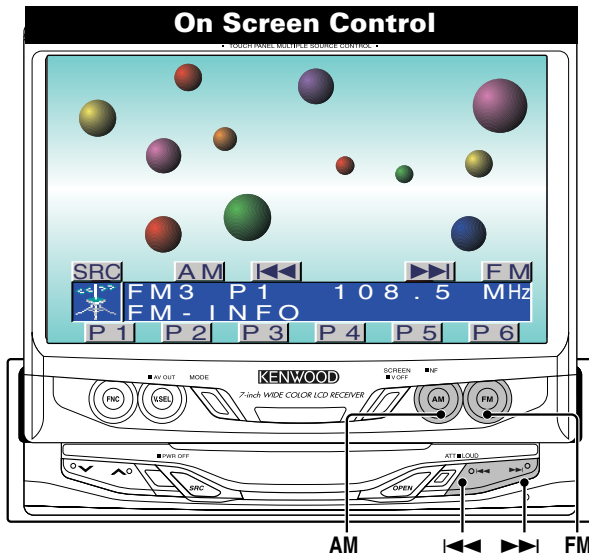

Selecting the FM Band

Press/ touch the [FM] button.
Each time the button is pressed/ touched it switches between the FM1, FM2, and FM3 bands.

Selecting the AM Band

Press/ touch the [AM] button.

Tuning

Press/ touch the [◀◀] or [▶▶] button.
During reception of stereo stations the "ST" indicator is ON

Station Preset Memory

Putting the station in the memory.

- Select the band**
Press/ touch the [FM] or [AM] button.
- Select the frequency to put in the memory**
Press/ touch the [◀◀] or [▶▶] button.
- Put the frequency in the memory**
Touch the [P1] — [P6] button for at least 2 seconds.
On each band, 1 station can be put in the memory on each [P1] — [P6] button.

Preset Tuning

Calling up the stations in the memory.

- Select the band**
Press/ touch [FM] or [AM] button.
- Call up the station**
Touch the [P1] — [P6] button.

Auto Memory Entry

Putting stations with good reception in the memory automatically.

- Select the band for Auto Memory Entry**
Touch the [FM] or [AM] button.
- Open Auto Memory Entry**
Touch the [AME] button for at least 2 seconds.
When 6 stations that can be received are put in the memory Auto Memory Entry closes.

Seek Mode

Sets the seeking mode.
Touch the [SEEK] button.
Each time the button is touched the seeking mode switches as shown below.

Seek mode(display)	Operation
Auto seek ("AUTO1")	Automatic search for a station.
Preset station seek ("AUTO2")	Search in order of the stations in the Preset memory.
Manual ("MANU")	Normal manual tuning control.

CRSC (Clean Reception System Circuit)

Temporarily have reception switched from stereo to mono to reduce multi-path noise when listening to the FM station.

Touch the [CRSC] button.
Each time the button is pressed CRSC turns ON or OFF.
When it's ON, the CRSC indicator is ON.

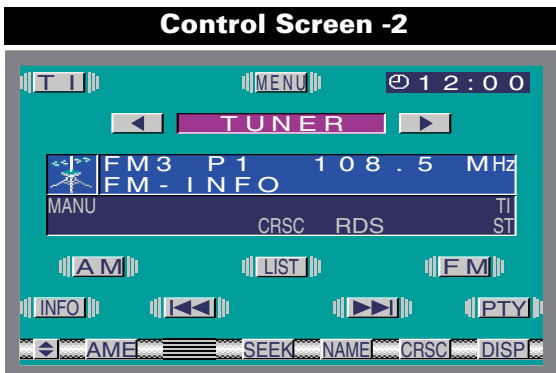

Traffic Information

Switching to traffic information automatically when a traffic bulletin starts even when you aren't listening to the radio.

Touch the [TI] button.
 Each time the button is touched the Traffic Information function turns ON or OFF.
 When it's ON, "TI" indicator is ON.
 When a traffic bulletin starts, "TRAFFIC INFO" is displayed and it switches to traffic information.

During reception of a AM station when the Traffic Information function is turned ON, it switches to a FM station.

Switching to the FM/AM List Screen

Touch the [LIST] button. (☛ page 22)

Switching to the PTY Search Screen

Touch the [PTY] button. (☛ page 22)

This function can't be used during a traffic bulletin or AM reception.

Switching to the Name Set Screen

Touch the [NAME] button.
 For the setting method refer to the name set screen (☛ page 28).

You cannot operate unless the parking brake is set.

Switching Display

Switching the information displayed.

Touch the [DISP] button.
 Each time the button is touched the display switches as shown below.

Information	Display
SNPS or Program Service name	"STATION NAME"
Radio text	"RADIO-TEXT"

Switching to the Radio Text Information Screen

The whole sentence of radio text is displayed.

Touch the [INFO] button.



Page Up/Down for the Radio text

Touch the [▲] or [▼] button.

When all text are displayed on the information screen, [▼] and [▲] do not appear.

Exit the Information Screen

Touch the [RTN] button.
 Return to the source control screen.

FM/AM Tuner Control Function

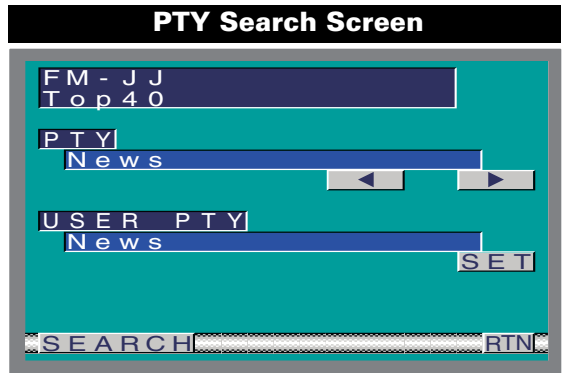
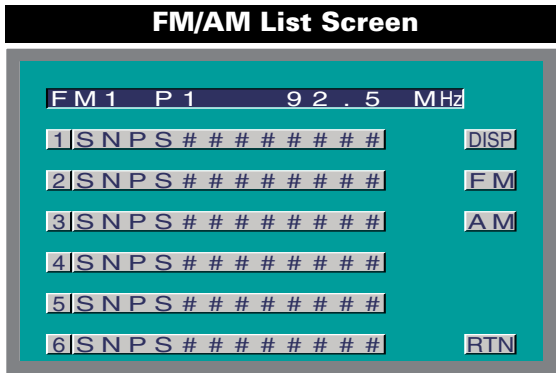

FM/AM List Screen

Selecting the FM band

Touch the [FM] button.
Each time the button is touched it switches between the FM1, FM2, and FM3 bands.

Selecting the AM band

Touch the [AM] button.

Switching the SNPS and PS Name

Touch the [DISP] button.

Call up the station

Touch the list.

Exit the FM/AM List Screen

Touch the [RTN] button.
Return to the source control screen.

PTY Search Screen

Selecting the Program Type and searching for a station.

Select the Program Type

Touch the [◀] or [▶] button.
Each time the button is touched the Program Type switches as shown below.

No.	Program Type	Display
1.	Speech	"All Speech"
2.	Music	"All Music"
3.	News	"News"
4.	Information	"Information"
5.	Sports	"Sports"
6.	Talk	"Talk"
7.	Rock	"Rock"
8.	Classic Rock	"Classic Rock"
9.	Adult Hits	"Adult Hits"
10.	Soft Rock	"Soft Rock"
11.	Top 40	"Top 40"
12.	Country	"Country"
13.	Oldies	"Oldies"
14.	Soft	"Soft"
15.	Nostalgia	"Nostalgia"
16.	Jazz	"Jazz"
17.	Classical	"Classical"
18.	R & B	"Rhythm & Blues"
19.	Soft R & B	"Soft R & B"
20.	Language	"Foreign Language"
21.	Religious Music	"Religious Music"

22.	Religious Talk	"Religious Talk"
23.	Personality	"Personality"
24.	Public	"Public"
25.	College	"College"
26.	Weather	"Weather"

Speech and Music include the Program type below.
Speech: No.3 — 6, 20, 22 — 26
Music: No.7 — 19, 21

Search for the selected Program Type station

Touch the [SEARCH] button.

When you want to search for other stations touch the [SEARCH] button again.

When the selected Program Type isn't found, "NO PTY" is displayed. Select another Program Type.

Registration of a station as a PTY

Registering a Program Type for stations with no PTY data.

Touch the [SET] button for at least 2 seconds.

Exit the PTY Search Screen

Touch the [RTN] button.
Return to the source control screen.

AV Control Function (TV Control: During the KTC-V500N is connected)

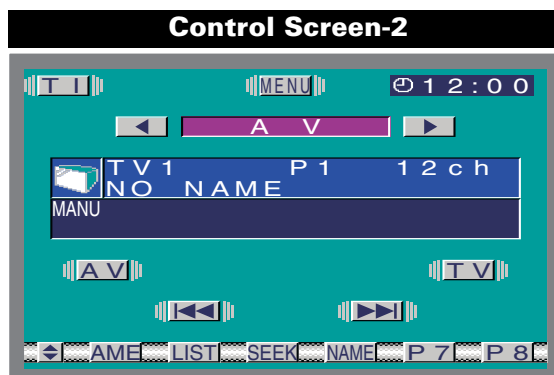
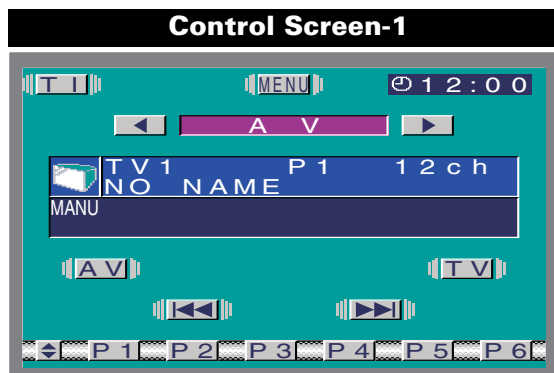
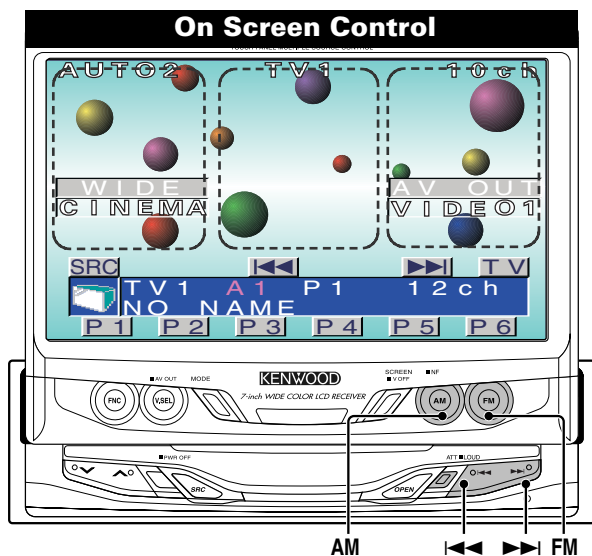

Selecting the On Screen Control

Touch the centre part.

If you make no button operation for 10 seconds, the on screen control is automatically cancelled.

Selecting the Preset Band

<In Monitor's button>

Press the [FM] button.

Each time the button is pressed the preset band switches between the TV1 and TV2.

<In Screen's button>

Touch the [TV] button.

Each time the button is touched the preset band switches between the TV1 and TV2.

Selecting the Video Input

<In Monitor's button>

Press the [AM] button.

Each time the button is pressed the video input switches between the AV IN 1, AV IN2 and RGB.

<In Screen's button>

Touch the [AV] button.

Each time the button is touched the video input switches between the AV IN 1, AV IN2 and RGB.

Video1 and 2: During "AV IN1" and "AV IN2" set to "VD",

Seek Mode

Sets the seeking mode.

Touch the [SEEK] button.

Each time the button is touched the seeking mode switches as shown below.

Seeking mode(display)	Operation
Auto seek ("AUTO1")	Automatic search for a station.
Preset station seek ("AUTO2")	Search in order of the stations in the Preset memory.
Manual ("MANU")	Normal manual seeking control.

Selecting the Channel

<In Monitor's button>

Press the [◀◀] or [▶▶] button.

<In Screen's button>

Touch the [◀◀] or [▶▶] button.

<On TV Picture>

Touch the left or right side part.

Station Preset Memory

Putting the station in the memory.

1 Select the band

Press/ touch the [FM] button.

2 Select the channel to put in the memory

Press/ touch the [◀◀] or [▶▶] button.

3 Put the channel in the memory

Touch the [P1] — [P8] button for at least 2 seconds.

On each band, 1 station can be put in the memory on each [P1] — [P8] button.

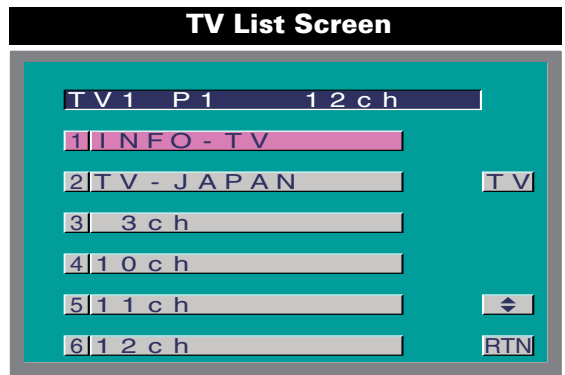
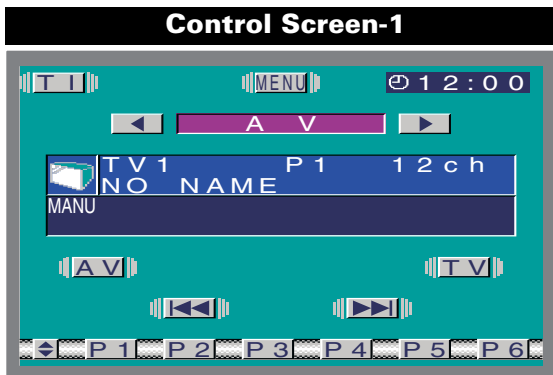

TV List Screen

Selecting the TV preset band

Touch the [TV] button.

Each time the button is touched it switches between the TV1, and TV2 bands.

Switching the List

Touch the [◀▶] button.

Each time the button is touched the list switches between the [P1] — [P6] and [P7] — [P8].

Call up the Channel

Touch the list.

Exit the TV List Screen

Touch the [RTN] button.

Return to the source control screen.

Auto Memory Entry

Putting stations with good reception in the memory automatically.

1 Select the band for Auto Memory Entry

Touch the [TV] button.

2 Open Auto Memory Entry

Touch the [AME] button for at least 2 seconds.

When 8 stations that can be received are put in the memory Auto Memory Entry closes.

Recalling a Preset Station

1 Select the band

2 Call up the station

Touch the [P1] — [P8] button.

Switching to the TV List Screen

Touch the [LIST] button.

Switching to the Name Set Screen

Touch the [NAME].

For the setting method refer to the name set screen (☛ page 28).

 You cannot operate unless the parking brake is set.

CD Player Control Function

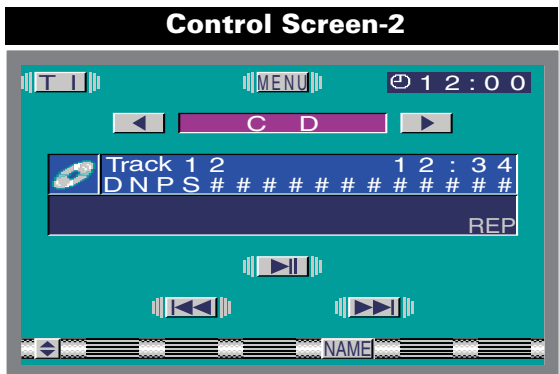
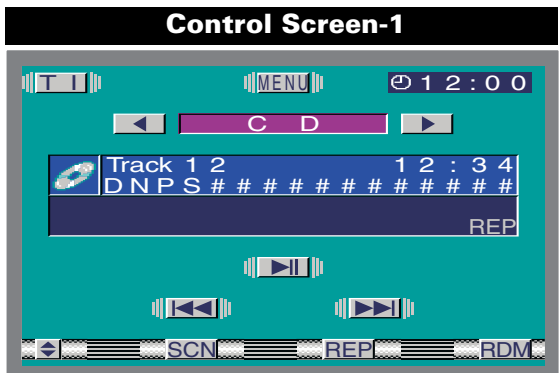
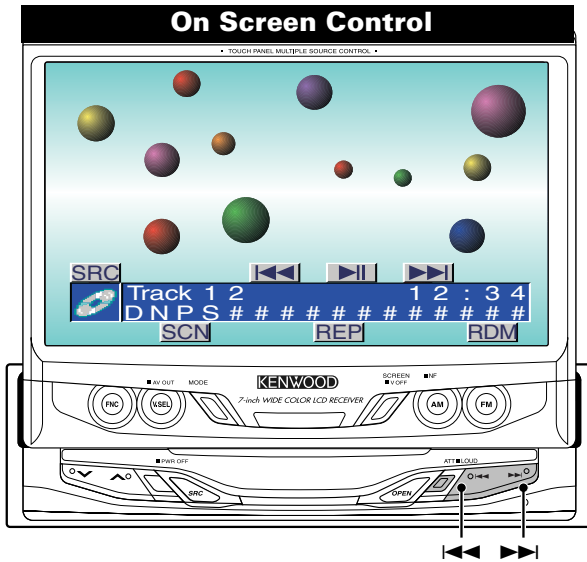

Pause and play

Touch the [▶||] button.
Each time the button is touched it pauses and plays.

Fast Forwarding and Reversing

Fast Forwarding

Hold down on the [▶▶] button.
Release your finger to play the disc at that point.

Reversing

Hold down on the [◀◀] button.
Release your finger to play the disc at that point.

Track Search

Selecting the song you want to hear.
Press/ touch the [◀◀] or [▶▶] button.

Track Repeat

Replaying the song you're listening to.
Touch the [REP] button.
Each time the button is touched the Track Repeat turns ON or OFF.
When it's ON, "REP" indicator is ON.

Track Scan

Playing the first part of each song on the disc you are listening to and searching for the song you want to listen to.

1 Start Track Scan

Touch the [SCN] button.
"SCN" indicator is ON.

2 Release it when the song you want to listen to is played

Touch the [SCN] or [▶||] button.

Random Play

Playing all the songs on the disc in random order.

Touch the [RDM] button.
Each time the button is touched Random Play turns ON or OFF.
When it's ON, the "RDM" indicator is ON.

☰ When the [▶||] button is touched, the next song select starts.

Switching to the Name Set Screen

Touch the [NAME] button.
For the setting method refer to the name set screen (▶ page 28).

☰ You cannot operate unless the parking brake is set.

Disc Changer Control Function

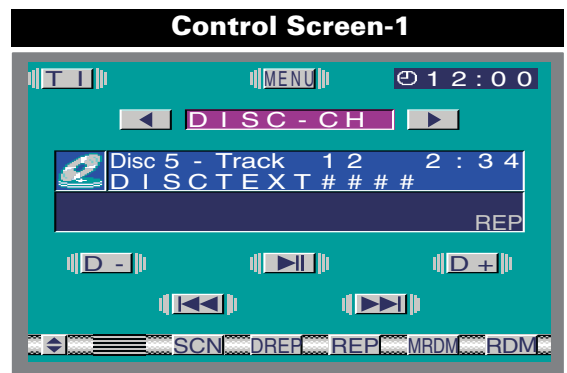
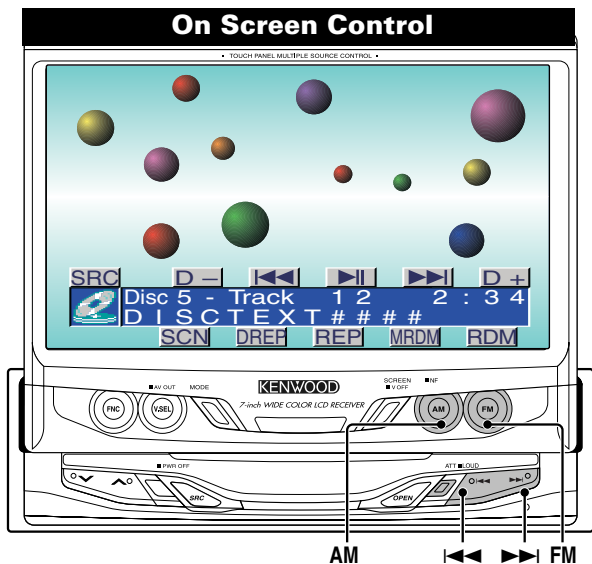

Pause and play

Touch the [▶||] button.
Each time the button is touched it pauses and plays.

Fast Forwarding and Reversing

Fast Forwarding:

Hold down on the [▶▶] button.
Release your finger to play the disc at that point.

Reversing:

Hold down on the [◀◀] button.
Release your finger to play the disc at that point.

Track Search

Selecting the song you want to hear.
Press/touch the [◀◀] or [▶▶] button.

Album Search

Selecting the disc you want to hear.
Touch the [D+] or [D-] button.
Press the [FM] or [AM] button.

The 3+1MD changer cannot be operated when 4 discs are inserted.

Track Repeat

Replaying the song you're listening to.
Touch the [REP] button.
Each time the button is touched the Track Repeat turns ON or OFF.
When it's ON, "REP" indicator is ON.

Album Repeat

Replaying the disc in the Disc changer you're listening to.

Touch the [DREP] button.
Each time the button is pressed Album Repeat turns ON or OFF.
When it's ON, the "DREP" indicator is ON.

The 3+1MD changer cannot be operated when 4 discs are inserted.

Track Scan

Playing the first part of each song on the disc you are listening to and searching for the song you want to listen to.

1 Start Track Scan

Touch the [SCN] button.
"SCN" indicator is ON.

2 Release it when the song you want to listen to is played

Touch the [SCN] or [▶||] button.

Random Play

Playing all the songs on the disc in random order.
Touch the [RDM] button.
Each time the button is touched Random Play turns ON or OFF.
When it's ON, the "RDM" indicator is ON.

When the [▶||] button is touched, the next song select starts.

Magazine Random Play

Play the songs on all the discs in the disc changer in random order.
Touch the [MRDM] button.
Each time the button is touched Magazine Random Play turns ON or OFF.
When it's ON, the "MRDM" indicator is ON.

• When the [▶||] button is touched, the next song select starts.
• The 3+1MD changer cannot be operated when 4 discs are inserted.

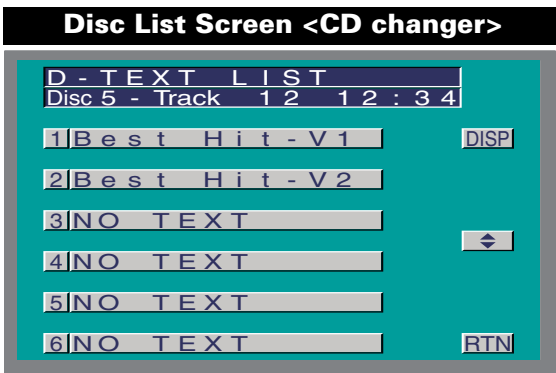
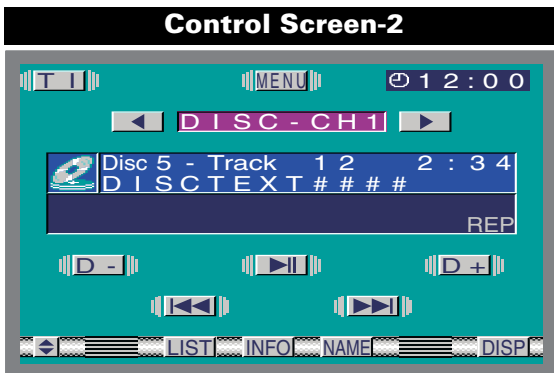

Switching Display

Touch the [DISP] button.
Each time the button is touched the display switches as shown below.

Display	Information
"DNPS"	Disc name (CD only)
"D-TEXT"/"D-TITLE"	Disc text/ Disc title
"T-TEXT"/"T-TITLE"	Track text/ Track title

Switching to the Text/Title Information Screen

The whole sentence of CD text or MD title is displayed.

Touch the [INFO] button.



Page Up/Down for the CD text or MD title

Touch the [▲] or [▼] button.

When all text are displayed on the information screen, [▼] and [▲] do not appear.

Exit the Information Screen

Touch the [RTN] button.
Return to the source control screen.

Switching to the Disc List Screen

Touch the [LIST] button.

Switching to the Name Set Screen

Touch the [NAME] button.
For the setting method refer to the name set screen (page 28).

You cannot operate unless the parking brake is set.

Disc List Screen <MD changer>

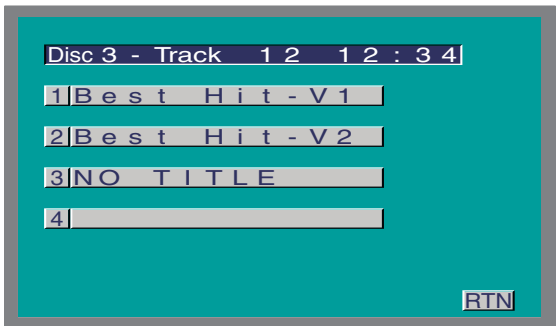

Disc List Screen

Changing the Disc List (10 disc changer only)

Touch the [◀▶] button.
Each time the button is touched the disc list switches between the disc1-6 and disc 7-10.

Switching the Display for Discs (CD only)

Touch the [DISP] button.
Each time the button is touched the list switches between the DNPS and CD text.

Selecting the Disc

Touch the list.

The 3+1MD changer cannot be operated when 4 disks are inserted.

Exit the Disc List Screen

Touch [RTN] button.
Return to the source control screen.

Name Set Function

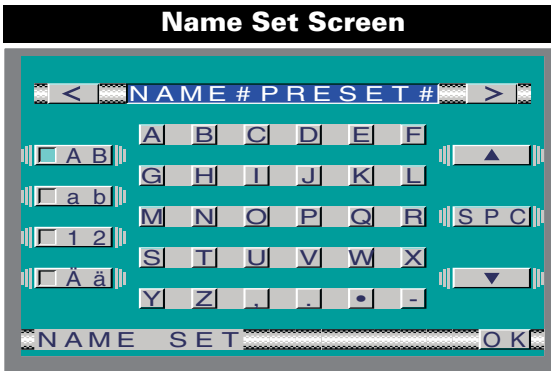

Station Name Preset (SNPS)/ Disc Name Preset (DNPS)

1 Move the cursor to the enter character position

Touch the [<] or [>] button.

2 Select the character type

Touch the [AB], [ab], [12] or [Ää] button.

3 Select the character list

Touch the [▼] or [▲] button.

When all characters are displayed on the character list, [▼] and [▲] do not appear.

4 Touch a character.

5 Repeat steps 1 through 4 and enter the name.

- You can enter up to 12 characters for each name.
- To enter a space, touch the [SPC] button.

6 Exit name set screen

Touch the [OK] button.

- Media that you can attach names to
 - FM/AM tuner: 30 FM/AM stations in all.
 - TV tuner: 100 stations.
 - External CD changer/ player: Varies according to the CD changer/ player manual.
- The name of a CD can be changed by the same operation you used to name it.

Other Option Control Function

Weather Band Tuner Control

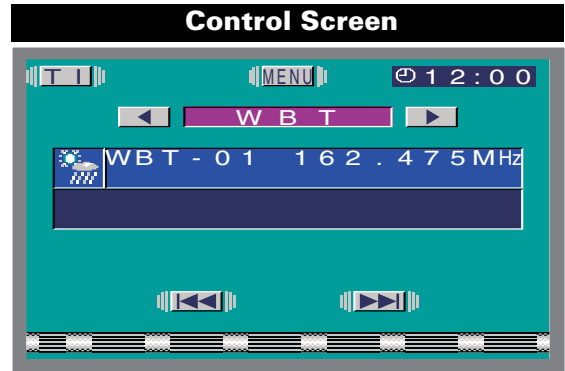
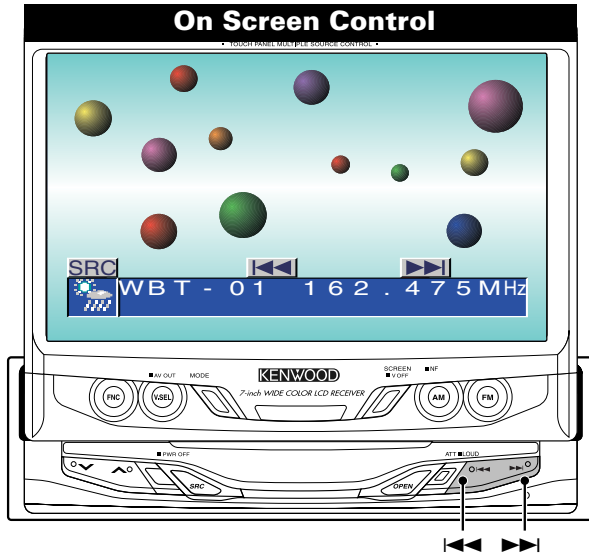

Selecting the Channels

<In Monitor's button>

Press the [◀◀] or [▶▶] button.

<In Screen's button>

Touch the [◀◀] or [▶▶] button.

Other Option Control Function

■ SIRIUS Tuner Control

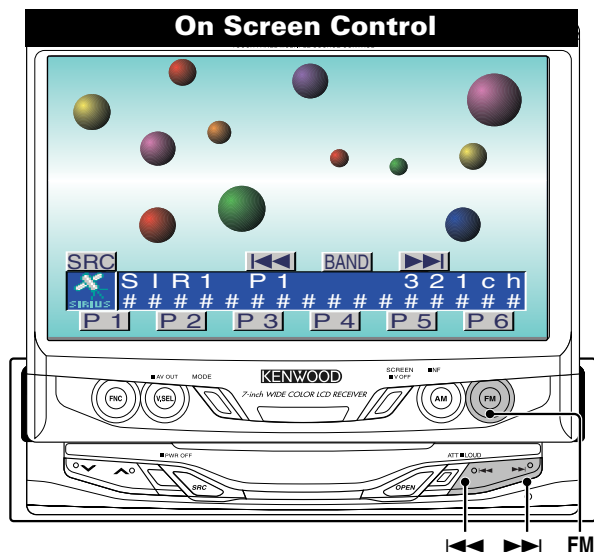

Selecting the Preset Band

<In Monitor's button>

Press the [FM] button.

Each time the button is pressed the preset band switches between the SIR1, SIR2, SIR3 and SIR4.

<In Screen's button>

Touch the [BAND] button.

Each time the button is touched the preset band switches between the the SIR1, SIR2, SIR3 and SIR4 .

Selecting the Channel

<In Monitor's button>

Press the [◀◀] or [▶▶] button.

<In Screen's button>

Touch the [◀◀] or [▶▶] button.

Station Preset Memory

Putting the channel in the memory.

1 Select the band

Press/ touch the [FM] or [BAND] button.

2 Select the channel to put in the memory

Press/ touch the [◀◀] or [▶▶] button.

3 Put the channel in the memory

Touch the [P1] — [P6] button for at least 2 seconds.

On each band, 1 station can be put in the memory on each [P1] — [P6] button.

Only the channel number is stored. Category information is not stored.

Seek Mode

Sets the seeking mode.

Touch the [SEEK] button.

Each time the button is touched the Seek mode switches as shown below.

Ddisplay	Operation
"SEEK1"	Normal manual seeking control.
"SEEK2"	Search in order of the channels in the Preset memory.

Channel Scan

Scanning for the channel you want to listen to.

1 Start Channel Scan

Touch the [SCN] button.

"SCN" indicator is ON.

2 Release it when the channel you want to listen to is selected

Touch the [SCN] button.

Channel Search

Searching the program category and Channel.

1 Switching to the category select screen

Touch the [SRCH] button

The category select screen is displayed.

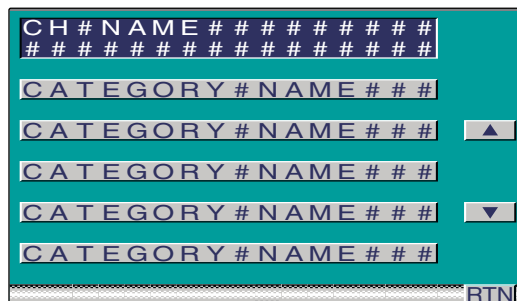

Canceling the category select screen

Touch [RTN] button.

Return to the source control screen.



2 Page Up/Down for the Category

Touch the [▲] or [▼] button.

3 Select the Category

Touch the list.

The channel select screen is displayed.

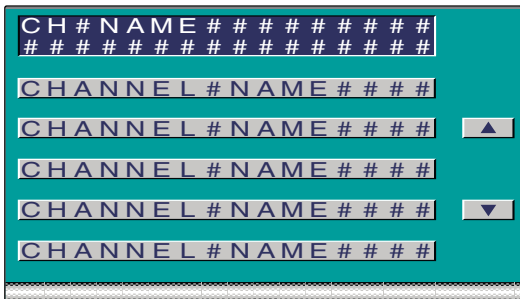

4 Page Up/Down for the Channel

Touch the [▲] or [▼] button.

5 Select the Channel

Touch the list.

Switching to the Information Screen

The whole sentence of SIRIUS information is displayed.

Touch the [INFO] button.

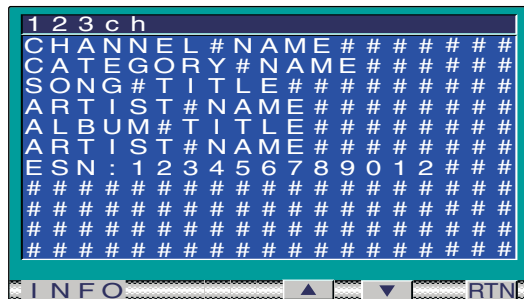

Page Up/Down for the text

Touch the [▲] or [▼] button.

When all text are displayed on the information screen, [▼] and [▲] do not appear.

Exit the Information Screen

Touch [RTN] button.

Return to the source control screen.

Program Descriptive Text

Program Descriptive Text data is song (or program) specific textual information that is transmitted to the receiver and displayed on Information screen.

Generally, most stations will contain the artist name and song title information. Additional information such as album and record label may also be provided.

[ESN] (Electronic Serial Number)

It is especially important to retain the unit serial number and the electronic Sirius Identification number for service activation and potential future service changes.

Other Option Control Function

■ External Display Control

External Display Control Screen



<Refer to the KPA-SD100 instruction manual for details on external box functions>

Switching the Display

Touch the [◀] or [▶] button.

Exit the External Display Control Screen

Touch the [RTN] button.
Return to the menu screen.

■ Sensor Box Control

Sensor Box Control Screen

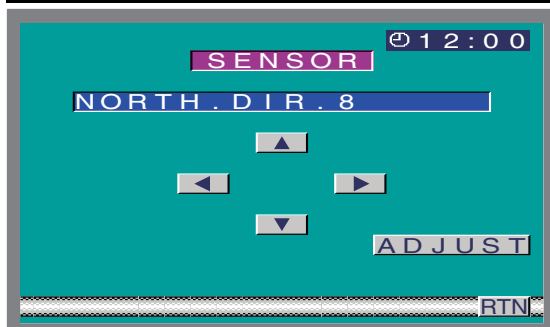

<Refer to the KPA-SS100 instruction manual for details on sensor box functions>

Setting the Menu

- 1 Touch the [ADJUST] button.

Select the item

Touch the [◀] or [▶] button.

Set the function

Touch the [▲] or [▼] button.

- 2 Touch the [ADJUST] button.

Exit the Sensor Box Control Screen

Touch the [RTN] button.
Return to the menu screen.



Remote Control Function

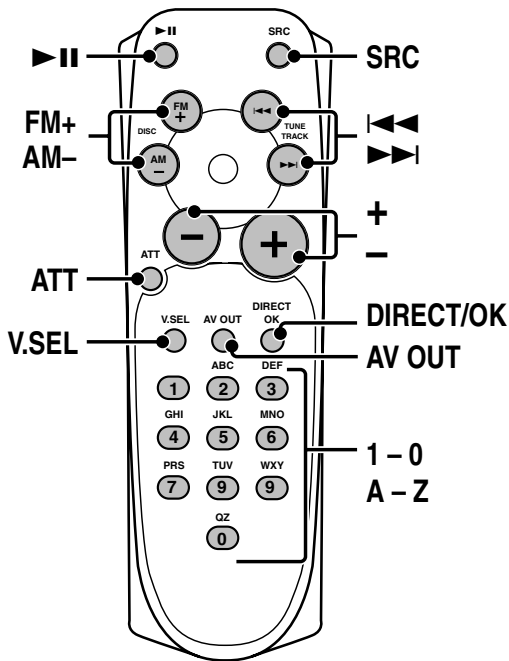

Monitor Control Function

- ▶ **Switching the Monitor's Picture**
Press the [V.SEL] button.
Each time the button is pressed the monitor's picture switches.
- ▶ **Switching the AV Output Mode**
Press the [AV OUT] button.
Each time the button is pressed the AV out mode switches.

Source Control Function (Common operation)

- ▶ **Select the Audio Source Mode**
Press the [SRC] button.
Each time the button is pressed the audio source switches.
- ▶ **Volume**
Increasing Volume
Press the [+] button.
Decreasing Volume
Press the [-] button.
- ▶ **Attenuator**
Press the [ATT] button.
Each time the button is pressed the Attenuator turns ON or OFF.

FM/AM Tuner Control Function

- ▶ **Selecting the FM band**
Press the [FM+] button.
- ▶ **Selecting the AM band**
Press the [AM-] button.
- ▶ **Tuning**
Press the [◀◀] or [▶▶] button.
- ▶ **Selecting the Seek Mode**
Press the [▶||] button.
Each time the button is pressed it switches between the AUTO1, AUTO2 and MANUAL seek mode.
- ▶ **Recalling Preset Station**
Press the [1] - [6] button.
- ▶ **Direct Search**
 - 1 Press the [DIRECT/OK] button to switch the direct search mode.
 - 2 Press the [0] - [9] buttons and enter the frequency.

Desired frequency	Press button
92.1 MHz (FM)	[#0], [#9], [#2], [#1]
810 kHz (AM)	[#0], [#8], [#1], [#0]

Loading and Replacing the Batteries for the Remote

CAUTION

Do not set the remote on hot places such as above the dashboard.

1. Use two "AAA" batteries.
Slide the cover while pressing downwards to remove it as illustrated.
2. Insert the batteries with the ⊕ and ⊖ poles aligned properly following the illustration inside the case.

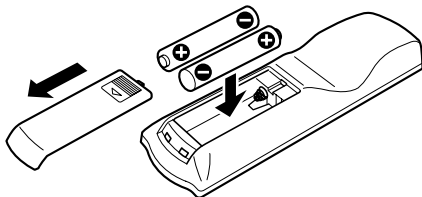

WARNING

Store unused batteries out of the reach of children. Contact a doctor immediately if the battery is accidentally swallowed.

- The provided batteries are intended for use in operation checking, and their service life may be short.
- When the remote controllable distance becomes short, replace both of the batteries with new ones.

AV Control Function

▶ Selecting the TV band

Press the [FM+] button.

Each time the button is pressed the preset band switches between the TV1 and TV2.

 This function available during the KTC-V500N is connected.

▶ Selecting the Video

Press the [AM-] button.

Each time the button is pressed the video input switches between the AV IN 1, AV IN2 and RGB.

▶ Selecting the Channel

Press the [◀◀] or [▶▶] button.

 This function available during the KTC-V500N is connected.

▶ Recalling Preset Channel

Press the [1] – [8] button.

 This function available during the KTC-V500N is connected.

▶ Selecting the Seek Mode

Press the [▶||] button.

Each time the button is pressed it switches between the AUTO1, AUTO2 and MANUAL seek mode.

 This function available during the KTC-V500N is connected.

▶ Direct Search

1 Press the [DIRECT/OK] button to switch the direct search mode.

2 Press the [0] – [9] buttons and enter the channel number.

Example:

Desired channel	Press button
3 ch	[#0], [#3]
47 ch	[#4], [#7]

 This function available during the KTC-V500N is connected.

SIRIUS Tuner Control Function

<During the KTC-SR901 is connected>

▶ Selecting the Preset Band

Press the [FM+] button.

Each time the button is pressed it switches between the SIR1, SIR2, SIR3 and SIR4 preset bands.

▶ Selecting the Channel

Press the [◀◀] or [▶▶] button.

▶ Selecting the Seek Mode

Press the [▶||] button.

Each time the button is pressed it switches between the SEEK1 and SEEK2.

▶ Recalling Preset Channel

Press the [1] – [6] button.

▶ Direct Search

1 Press the [DIRECT/OK] button to switch the direct search mode.

2 Press the [0] – [9] buttons and enter the channel number.

2 Press the [◀◀] or [▶▶] button.

Weather Band Control Function

<During the KTC-WB100 is connected>

▶ Selecting the Channel

Press the [◀◀] or [▶▶] button.

Disc Control Function

<During the disc changer or player is connected>

▶ Pause and play

Press the [▶||] button.

Each time the button is pressed it pauses and plays.

▶ Track Search

Press the [◀◀] or [▶▶] button.

▶ Direct Track Search

1 Press the [0] – [9] buttons and enter the track number.

2 Press the [◀◀] or [▶▶] button.

▶ Album Search (Function of disc changer)

Press the [FM+] or [AM-] button.

▶ Direct Album Search (Function of disc changer)

1 Press the [0] – [9] buttons and enter the disc number.

2 Press the [FM+] or [AM-] button.

Installation

Accessories

 The use of any accessories except for those provided might result in damage to the unit. Make sure only to use the accessories shipped with the unit, as shown above.

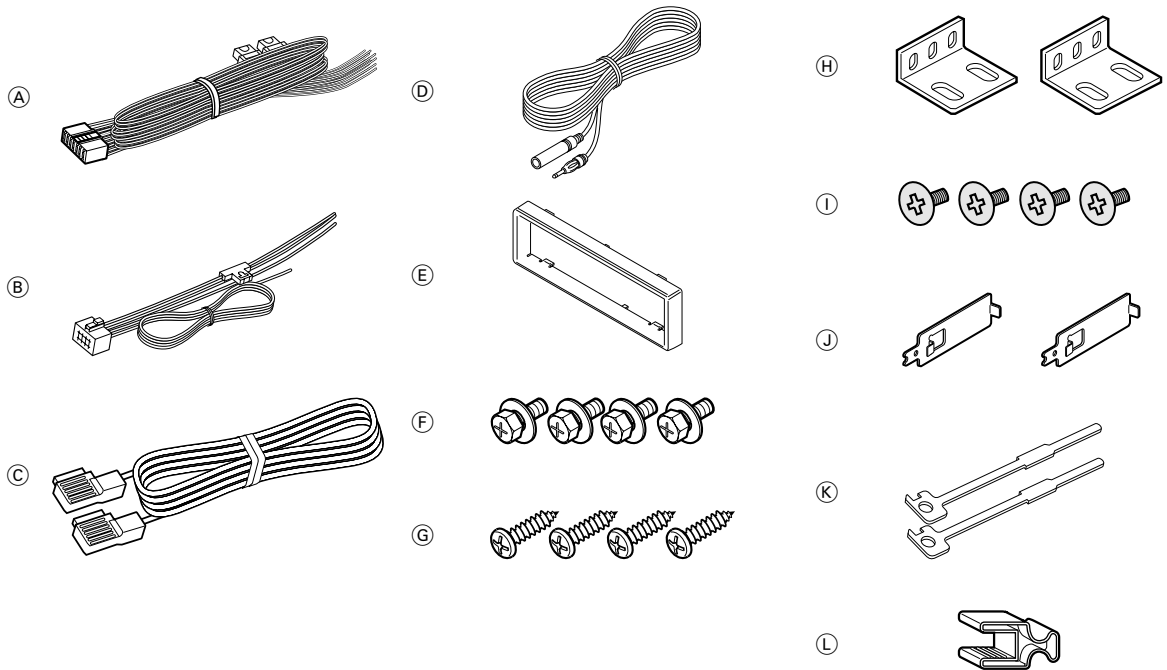

Installation Procedure

1. To prevent short circuits, remove the key from the ignition and disconnect the \ominus terminal of the battery.
 2. Make the proper input and output cable connections for each unit.
 3. Connect the speaker wires of the wiring harness.
 4. Connect the wiring harness wires in the following order: ground, battery, ignition.
 5. Connect the wiring harness connector to the unit.
 6. Install the unit in your car.
 7. Reconnect the \ominus terminal of the battery.
 8. Press the reset button. (See p. 4)
- Insulate unconnected wires with vinyl tape or other similar material.
 - During use, the surface temperature of this unit will become high, therefore it should not be mounted where anything sensitive to the heat, such as people or resins, would come into contact with it.
 - Do not install the receiver unit under the carpet. Otherwise heat build-up occurs and the unit may be damaged.
 - Mount the unit so that the mounting angle is 30° or less.

-  • If your car's ignition does not come with an ACC position, connect the ignition wires to a power source that can be turned on and off with the ignition key. If you connect the ignition wire to a power source that receives a constant voltage supply, as with battery wires, the battery may die.
- If the fuse blows, first make sure that the wires have not caused a short circuit, then replace the old fuse with one with the same rating.
 - Do not let unconnected wires or terminals touch metal on the car or anything else conducting electricity. To prevent short circuits do not remove the caps from unused terminals or from the ends of the unconnected wires.
 - After the unit is installed, check whether the brake lamps, blinkers, wipers, etc. on the car are working properly.

Installation for Monitor Unit

- ⚠ When mounting the main unit after checking the operation, close the monitor first.
- 🗨 Make sure that the unit is installed securely in place. If the unit is unstable, it may malfunction.

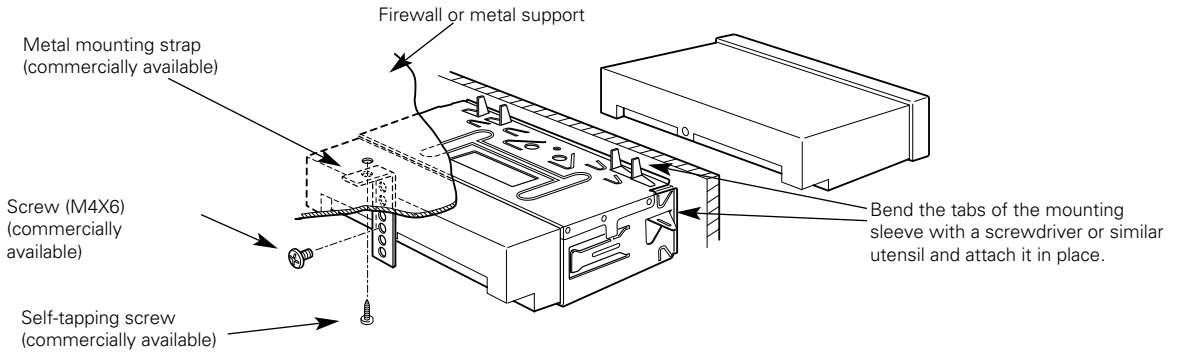

■ Installing in Japanese-Made Cars-1

When the vehicle bracket is attached as in Toyota, Nissan, Mitsubishi, and other vehicles that use a hole in the ● position in the figure below.

Not use the Hard Rubber Frame (Accessory ⑥).

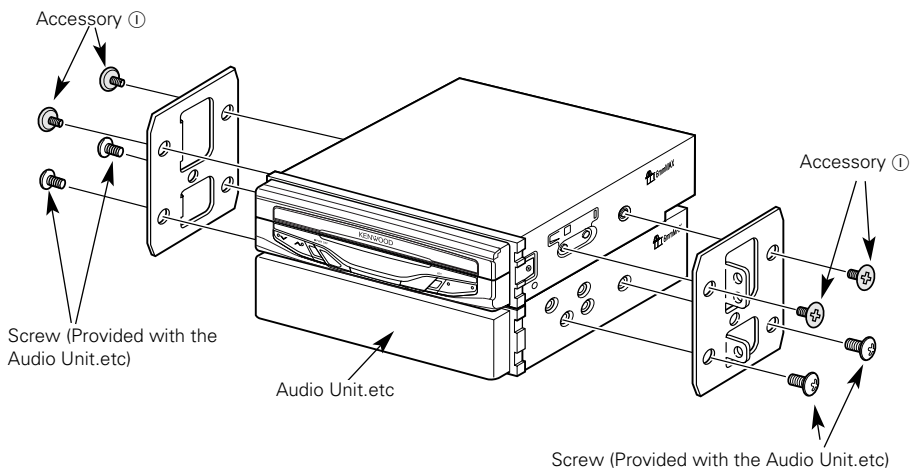
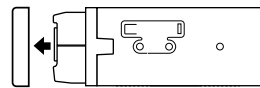
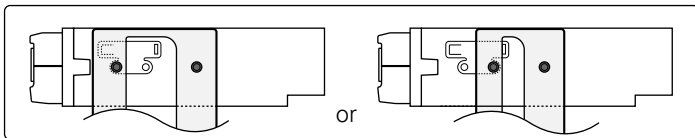

Installation

■ Installing in Japanese-Made Cars-2

When the vehicle bracket is attached as in Toyota vehicles that use a hole in the ● position in the figure below.

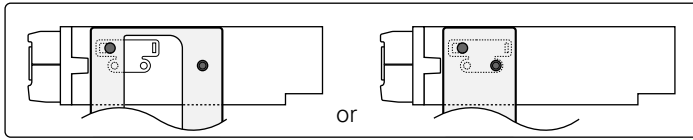

Not use the Hard Rubber Frame (Accessory ⑤).

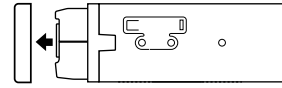

If this device can't be fastened with screws in the 2 places on the right and left due to the vehicle bracket shape, use the installation fastener (Accessory ④) and fasten the bracket.

1 Fasten Accessory ④ on both sides as shown in the figure below.

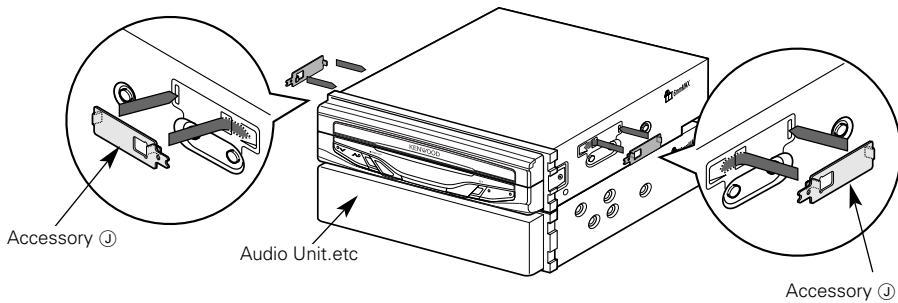

2 Fasten the vehicle bracket.

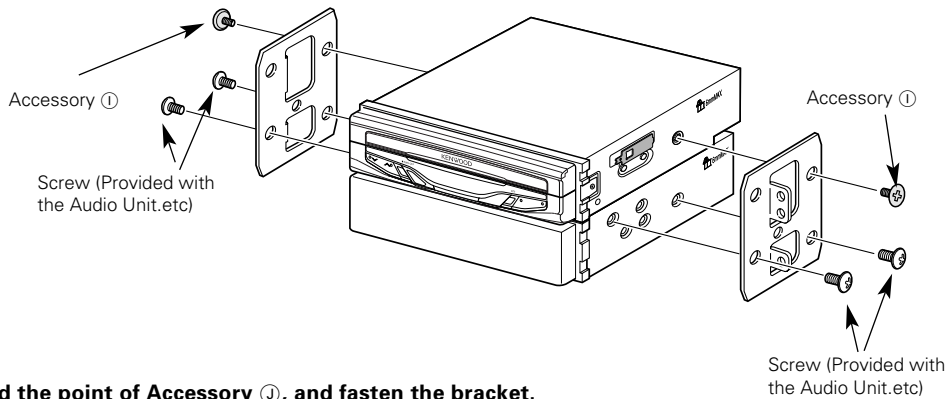

3 Bend the point of Accessory ④, and fasten the bracket.

Using a screwdriver or pliers bend the right and left of Accessory ④ so that it can be fastened to the vehicle bracket hole.

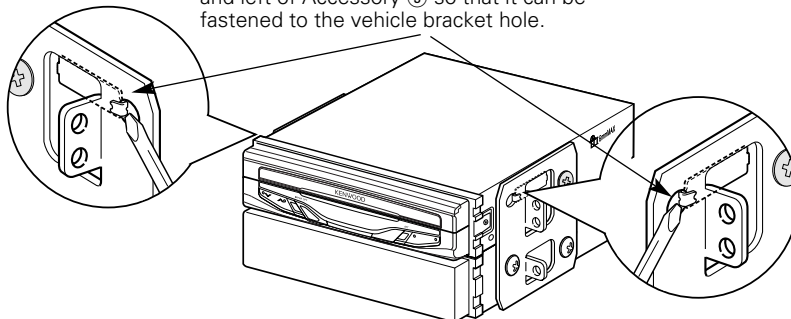

Installation for Receiver unit

■ Securing to audio board

- 1 Attach the installation brackets to the sides of the hideaway unit using the sems bolts (M4 × 8 mm).

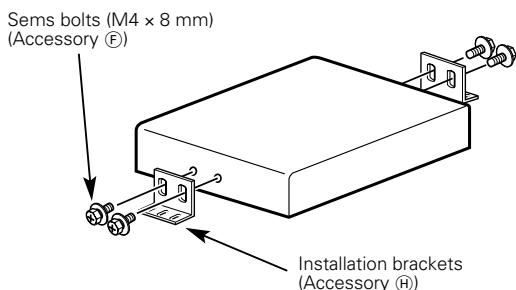

- 2 Use the tapping screw (ø4 × 16 mm) to secure the hideaway unit to the audio board.

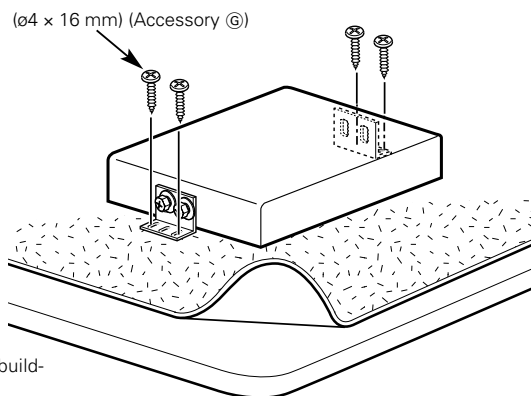

⚠ Do not install the receiver unit under the carpet. Otherwise heat build-up occurs and the unit may be damaged.

Removing Monitor Unit

■ Removing the Hard Rubber Frame

- 1 Engage the catch pins on the removal tool and remove the two locks on the lower level. Lower the frame and pull it forward as shown in the figure.

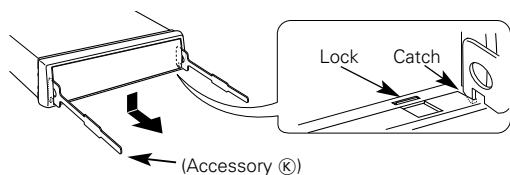

- 2 When the lower level is removed, remove the upper two locations.

💬 The frame can be removed from the top side in the same manner.

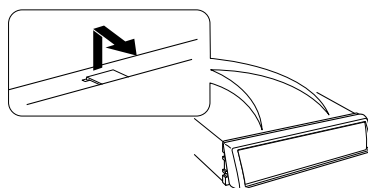

■ Removing the Unit

- 1 Refer to the section "Removing the Hard Rubber Frame" and then remove the hard rubber frame.
- 2 Remove the screw (M4×6) on the back panel.
- 3 Insert the two removal tools deeply into the slots on each side, as shown.

- 4 Lower the removal tool toward the bottom, and pull out the unit halfway while pressing towards the inside.

⚠ Be careful to avoid injury from the catch pins on the removal tool.

- 5 Pull the unit all the way out with your hands, being careful not to drop it.

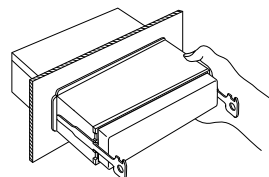
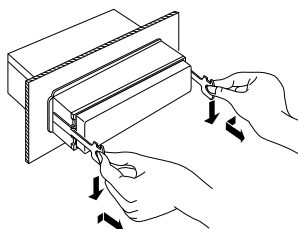
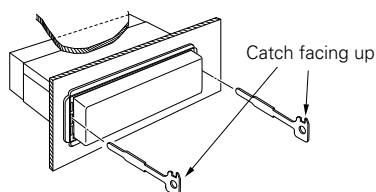

Installation

Connection

⚠ WARNING

If you connect the ignition wire (red) and the battery wire (yellow) to the car chassis (ground), you may cause a short circuit, that in turn may start a fire. Always connect those wires to the power source running through the fuse box.

When detaching the connection cable, use the accessory tool (Accessory-Ⓒ) as shown in the diagram.

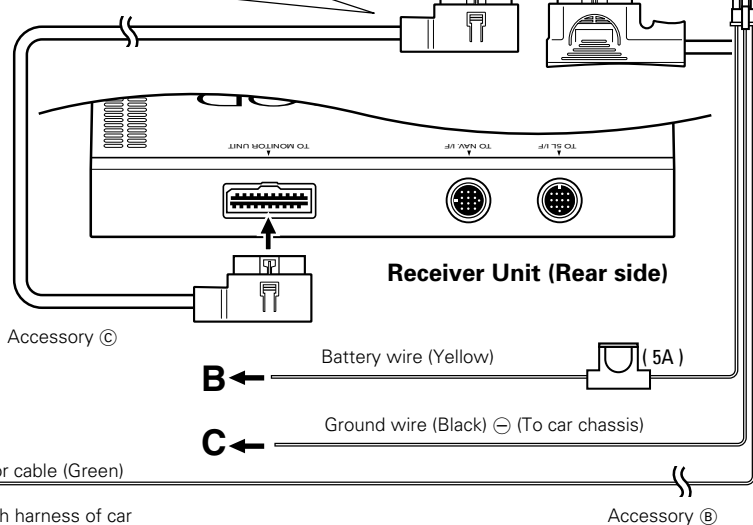
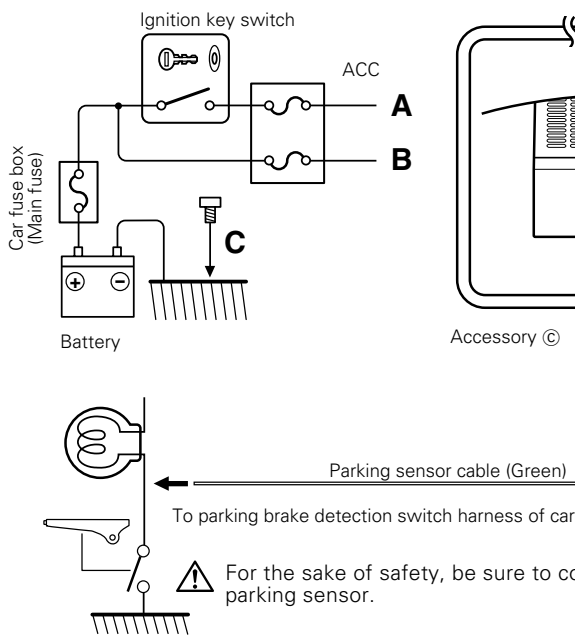
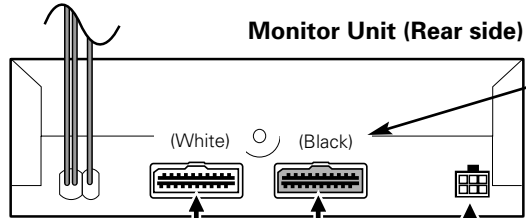
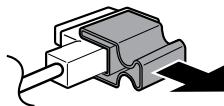

Receiver Unit (Front side)

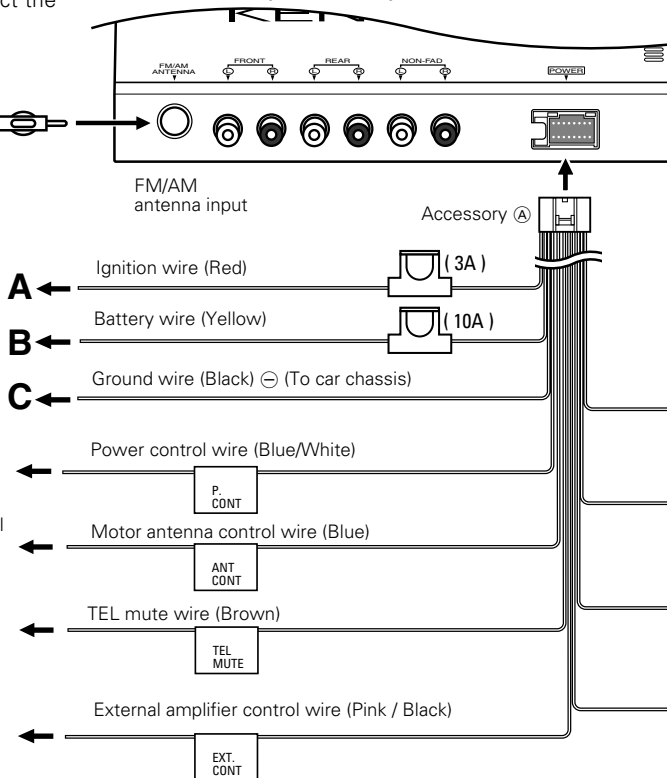

When using the optional power amplifier, connect to its power control terminal.

Depending on what antenna you are using, connect either to the control terminal of the motor antenna, or to the power terminal for the booster amplifier of the film-type antenna.

Connect to the terminal that is grounded when either the telephone rings or during conversation.

To connect the KENWOOD navigation system, consult your navigation manual.

To "EXT.AMP.CONT." terminal of the amplifier having the external amp control function.

Remove the protective sheet on the black connector before the KTC-V500N is connected.

KTC-V500N (Optional)

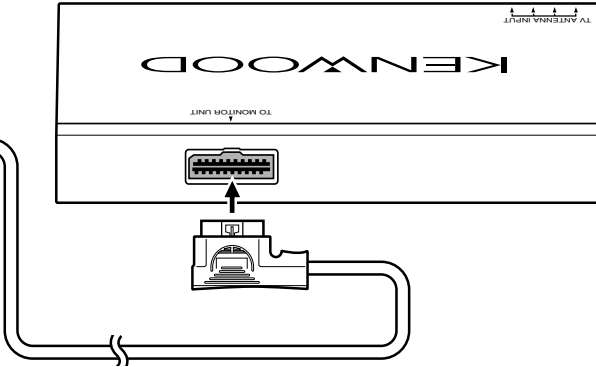

Connection cable
(Provided with the KTC-V500N)

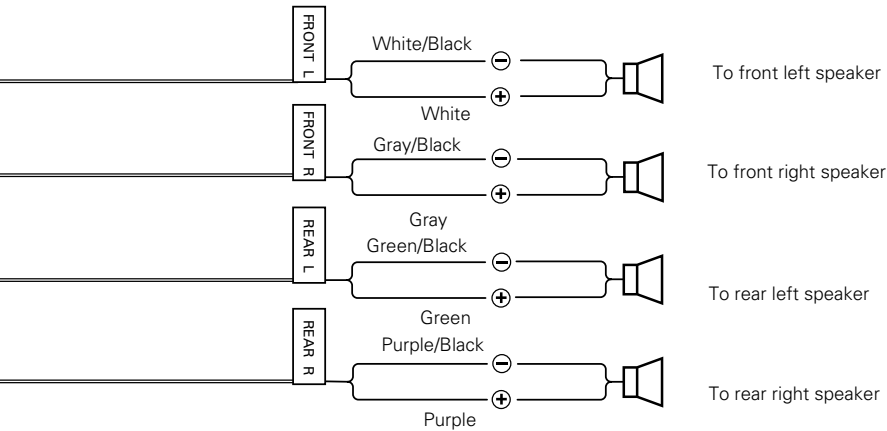

Installation

Connection for AV Equipments

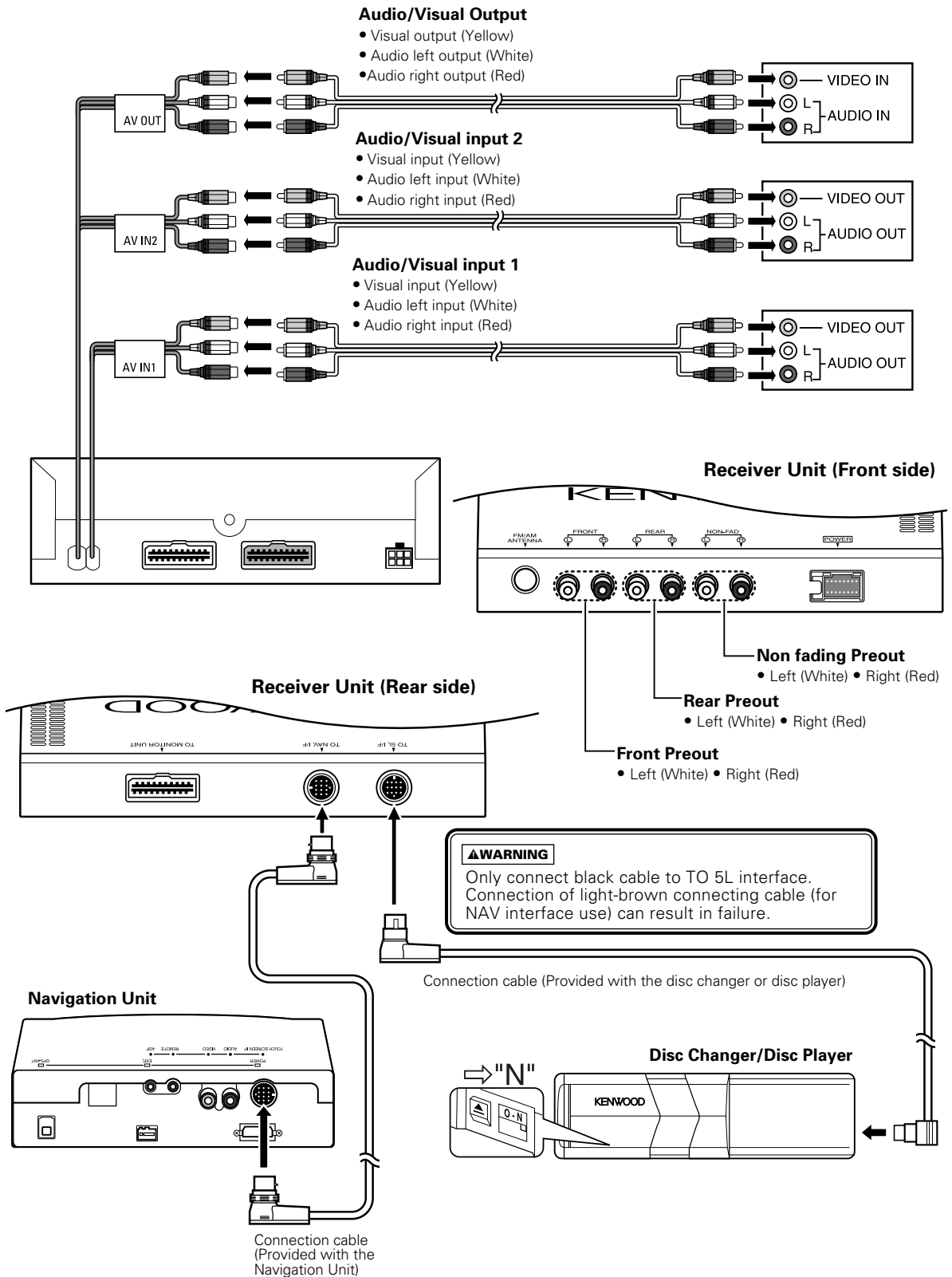

Troubleshooting Guide

What might appear to be a malfunction in your unit may just be the result of slight misoperation or miswiring. Before calling service, first check the following table for possible problems.

General

? The power does not turn ON.

- ✓ The fuse has blown.
☞ After checking for short circuits in the wires, replace the fuse with one with the same rating.
- ✓ No ACC position on vehicle ignition.
☞ Connect the same wire to the ignition as the battery wire.

? Nothing happens when the buttons are pressed.

- ✓ The computer chip in the unit is not functioning normally.
☞ Press the reset button on the unit (page 4)..

? The monitor does not open/close.

- ✓ The unit is not connected to the parking brake detection switch.
☞ Make proper connections according to <Connection> (See page 40).
- ✓ The parking brake is not engaged.
☞ For safety reasons, the monitor does not open while the vehicle is moving. Engaging the parking brake.

? The screen is dark.

- ✓ The unit is in a location where temperature is low.
☞ If the temperature of the monitor unit drops, the screen may appear darker when power is first turned on due to the characteristics of a liquid crystal panel. Wait a while after turning power on for the temperature to rise. Normal brightness will return.

? Nothing happens when the buttons are pressed.

- ✓ The computer chip in the unit is not functioning normally.
☞ Press the reset button on the unit (page 4).

? The memory is erased when the ignition is turned OFF.

- ✓ The battery wire has not been connected to the proper terminal.
☞ Connect the wire correctly, referring to the section on <Connection>.
- ✓ The ignition and battery wire are incorrectly connected.
☞ Connect the wire correctly, referring to the section on <Connection>.

? There's no loudness effect.

- ✓ You're using Non-fading preout.
☞ Loudness has no effect in Non-fading preout.

? The TEL mute function does not work.

- ✓ The TEL mute wire is not connected properly.
☞ Connect the wire correctly, referring to the section on <Connection>.

? The TEL mute function turns ON even though the TEL mute wire is not connected.

- ✓ The TEL mute wire is touching a metal part of the car.
☞ Pull the TEL mute wire away from the metal part of the car.

? Even if Loudness is turned ON, high-pitched tone isn't compensated for.

- ✓ Tuner source is selected.
☞ High-pitched tone isn't compensated for when in Tuner source.

? No sound can be heard, or the volume is low.

- ✓ The fader or balance settings are set all the way to one side.
☞ Center the fader and balance settings.
- ✓ The input/output wires or wiring harness are connected incorrectly.
☞ Reconnect the input/output wires or the wiring harness correctly. See the section on <Connection>.
- ✓ The values of Volume offset are low.
☞ Increase the values of Volume offset. (page 15)

? The sound quality is poor or distorted.

- ✓ One of the speaker wires is being pinched by a screw in the car.
☞ Check the speaker wiring.
- ✓ The speakers are not wired correctly.
☞ Reconnect the speaker wires so that each output terminal is connected to a different speaker.

? Non-fading output, Non-fading Low Pass Filter and Non-fading setting can't be done.

- ✓ The <Non-fading output> (page18) is OFF.
☞ Turn it ON.
- The <Dual zone system> (page 15) is ON.
☞ Turn it OFF.

? There's no Front High Pass Filter and Rear High Pass Filter effect.

- ✓ The Non-fading preout is being used.
☞ There's no effect in Non-fading preout.

? The Security Code item isn't displayed in the Menu System.

- ✓ The Security Code function is already activated.
☞ When the Security Code function is activated it isn't displayed in the menu items.

? The Touch Sensor Tone doesn't sound.

- ✓ The preout jack is being used.
☞ The Touch Sensor Tone can't be output from the preout jack.

? Even though Synchronize Clock is ON, the clock can't be adjusted.

- ✓ The received RDS station isn't sending time data.
☞ Receive another RDS station.

Tuner source

? Radio reception is poor.

- ✓ The car antenna is not extended.
☞ Pull the antenna out all the way.
- ✓ The antenna control wire is not connected.
☞ Connect the wire correctly, referring to the section on <Connection>.

? The desired frequency can't be entered with the Direct Access Tuning.

- ✓ A station that can't be received is being entered.
☞ Enter a station that can be received.
- ✓ You're trying to enter a frequency with a 0.01 MHz unit.
☞ What can be designated in the FM band is to 0.1 MHz.

? It isn't the set Traffic information sound volume.

- ✓ The set sound volume is less than the tuner sound volume.
☞ If the tuner sound volume is louder than the set sound volume, the tuner sound volume is used.

Troubleshooting Guide

Disc source

? "AUX" is displayed without achieving External disc control mode.

- ✓ O-N switch is set to "O" side.
 - ☞ Set the switch to "N" side.
- ✓ Unsupported disc changer is connected.
 - ☞ Connect the supported disc changer. (page 4)

? The specified disc does not play, but another one plays instead.

- ✓ The specified CD is quite dirty.
 - ☞ Clean the CD.
- ✓ The CD is upside-down.
 - ☞ Load the CD with the labeled side up.
- ✓ The disc is loaded in a different slot from that specified.
 - ☞ Eject the disc magazine and check the number for the specified disc.
- ✓ The disc is severely scratched.
 - ☞ Try another disc instead.

? The specified track will not play.

- ✓ Random play or magazine random play has been selected.
 - ☞ Turn off random play or magazine random play.

? Track repeat, disc repeat, track scan, random play, and magazine random play start by themselves.

- ✓ The setting is not canceled.
 - ☞ The settings for these functions remain on until the setting to off or the disc ejected, even if the power is turned off or the source changed.

? The specified track will not play.

- ✓ Random play has been selected.
 - ☞ Turn off random play.

? Track repeat, disc repeat, track scan, and random play, start by themselves.

- ✓ The setting is not canceled.
 - ☞ The settings for these functions remain on until the setting to off or the disc ejected, even if the power is turned off or the source changed.

? Cannot play CD-R or CD-RW.

- ✓ Finalization processing is not being conducted for CD-R/CD-RW.
 - ☞ Conduct finalization processing with CD recorder.
- ✓ A non-compatible CD changer is being used to play the CD-R/CD-RW.
 - ☞ Use a CD changer compatible with CD-R/CD-RW to play.

? Direct Track Search and Direct Disc Search can't be done.

- ✓ Another function is ON.
 - ☞ Turn Random Play or other functions OFF.

? Track Search can't be done.

- ✓ For the albums first or last song.
 - ☞ For each album, Track Search can't be done in the backward direction for the first song or in the forward direction for the last song.

If the following situations, consult your nearest service center:

- Even though the disc changer is connected, the Disc Changer source is not ON, with "AUX" showing in the display during the Changer Mode.
- Even though no device (KCA-S210A, CA-C1AX, KDC-CPS87, KDC-CX87, KDC-CPS85, KDC-CX85, KDC-CPS82 or KDC-CX82) is connected, the Auxiliary input is entered when switching modes.

The following messages are displayed when certain problems are occurring in your system. Take the recommended actions.

EJECT: No disc magazine has been loaded in the changer. The disc magazine is not completely loaded.
⇨ Load the disc magazine properly.
No CD in the unit.
⇨ Insert the CD.

NO DISC: No disc has been loaded in the disc magazine.
⇨ Load a disc into the disc magazine.

READ ERROR: No disc has been loaded in the disc magazine.
⇨ Load a disc into the disc magazine.
The CD is quite dirty. The CD is upside-down.
The CD is scratched a lot.
⇨ Clean the CD and load it correctly.

BLANK DISC: Nothing has been recorded on the MD.

NO TRACK DISC: No tracks are recorded on the MD, although it has a title.

NO PANEL: The faceplate of the slave unit being connected to this unit has been removed.
⇨ Replace it.

E-77: The unit is malfunctioning for some reason.
⇨ Press the reset button on the unit. If the "E-77" code does not disappear, consult your nearest service center.

MECHA ERROR: Something is wrong with the disc magazine. Or the unit is malfunctioning for some reason.
⇨ Check the disc magazine. And then press the reset button on the unit. If the "Mecha Error" code does not disappear, consult your nearest service center.

E-99: The unit is malfunctioning for some reason.
⇨ Press the reset button on the unit. If the "E-99" code does not disappear, consult your nearest service center.

HOLD ERROR: The protective circuit in the unit activates when the temperature inside the automatic disc changer exceeds 60°C (140°F), stopping all operation.
⇨ Cool down the unit by opening the windows or turning on the air conditioner. As the temperature falls below 60°C (140°F), the disc will start playing again.

NO NAME:

- Attempted to display SNPS during the receiving session of the station having no station name preset.
- Attempted to display DNPS during the CD play having no disc names preset.

NO TLTL: Attempted to display the disc title or track title while the MD having no MD title is being played.

NO TEXT:

- Attempted to display the disc text or track text while the CD having no CD text is being played.
- Attempted to display text during reception of the station that isn't sending text data.

WAITING: Radio text data is being received.

LOAD: Discs are being exchanged in the Disc changer.

NO ACCESS: After setting it in the Disc Changer, Disc list Screen was done without having it been played at least 1 time.

Specifications

Specifications subject to change without notice.

Monitor Section

Picture size	7.0 inches wide (154.1 mm x 87.0 mm)
Display system	Transparent TN LCD panel
Drive system	TFT active matrix system
Number of pixels	336,960 pixels (480 H x 234 V x RGB)
Effective pixels	99.99%
Pixel arrangement	RGB striped arrangement
Back lighting	Cold cathode tube

FM tuner section

Frequency range (50 kHz space)	87.5 MHz – 107.9 MHz
Usable sensitivity (S/N = 26dB)	9.3 dBf (0.8 μ V/75 Ω)
Quieting Sensitivity (S/N = 46dB)	15.2 dBf (1.6 μ V/75 Ω)
Frequency response (\pm 3.0 dB)	30 Hz – 15 kHz
Signal to Noise ratio (MONO)	75 dB
Selectivity (\pm 400 kHz)	\geq 80 dB
Stereo separation (1 kHz)	40 dB

AM tuner section

Frequency range	530 kHz – 1700 kHz
Usable sensitivity	28 dB μ

Visual section

External video input level (RCA jacks)	1 V _{p-p} / 75 Ω
External audio input level (RCA jacks)	1 V/ 22 K Ω
Analog RGB input	0.7 V _{p-p} / 75 Ω
Color system	NTSC

Audio section

Maximum output power	47 W x 4
Output power (at less than 1% THD)	22 W x 4
Tone action	
Bass:	100 Hz \pm 10 dB
Middle:	1 kHz \pm 10 dB
Treble:	10 kHz \pm 10 dB
Preout level / Load	4.5 V/10 k Ω
Preout impedance	\leq 600 Ω

General

Operating voltage	14.4 V DC (11 to 16 V)
Consumed current	10 A
Operational temperature range	-10°C to +60°C
Storage temperature range	-20°C to +85°C
Size	
(Monitor unit)	180(W) x 50(H) x 193(D) mm(7-1/16 x 1-15/16 x 9/16 inch)
(Receiver unit)	217(W) x 30(H) x 155(D) mm(8-9/16 x 1-3/16 x 6-1/8 inch)
Installation size (Monitor unit)	178(W) x 50(H) x 165(D) mm(7 x 1-15/16 x 6-1/2 inch)
Mass	
(Monitor unit)	1.8 kg (4.0 LBS)
(Receiver unit)	0.86 kg (1.9 LBS)

Although the effective pixels for the liquid crystal panel is given as 99.99% or more, 0.01% of pixels may not light or may light incorrectly.

KENWOOD